

NEW

ISSUE 1

Part of the *Fabulous* pattern series

Fabulous

AUGUST 2024

EMBROIDERY PATTERNS

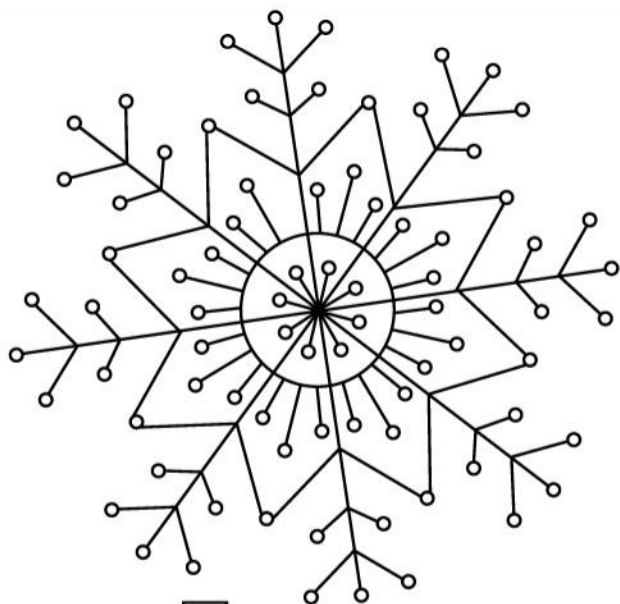

Christmas

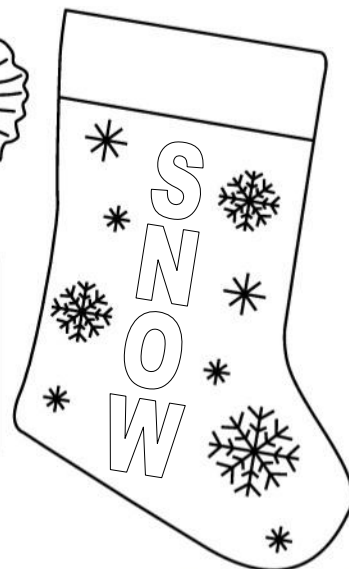
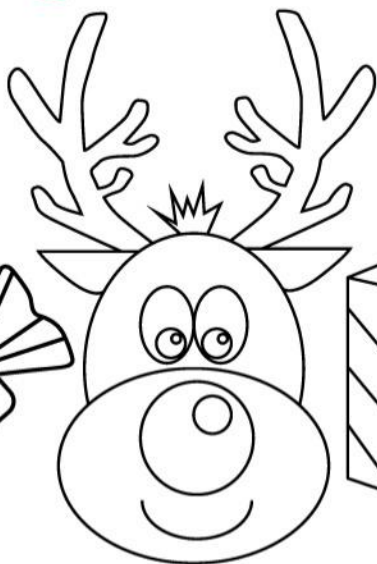
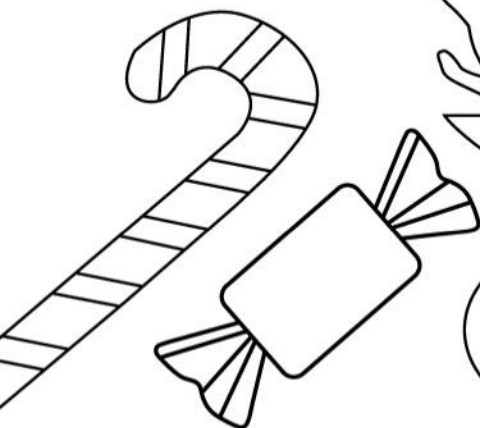

Over **50** *Fabulous* patterns to make inside

NEW

ON SALE NOW

WWW.FABULOUSPATTERNS.CO.UK

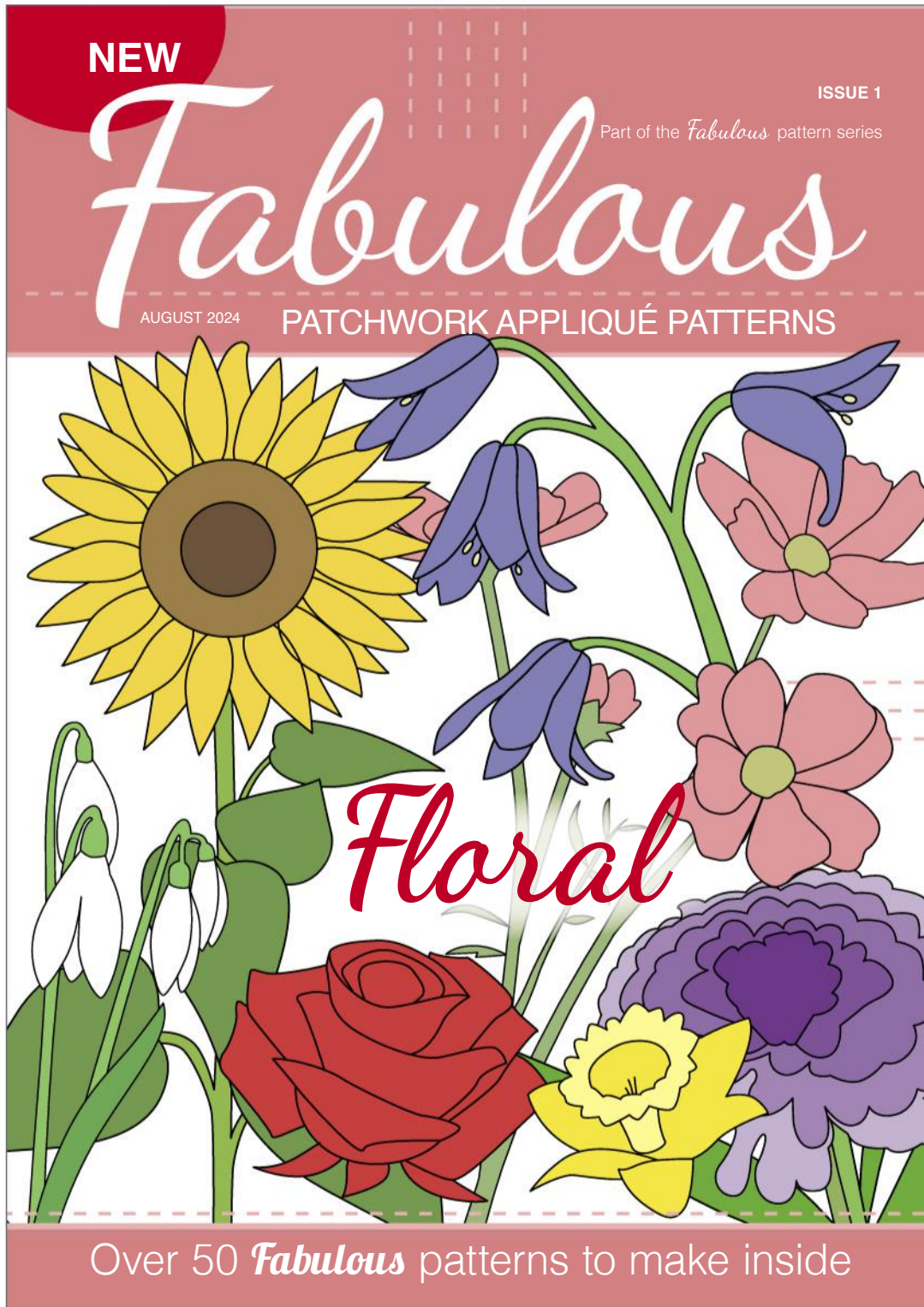

THEMED PATTERNS – ALL SKILL LEVELS – EVERY MONTH

Part of the *Fabulous* pattern series

Christmas

embroidery

A warm welcome to the world of the *Fabulous* Pattern Series. We are a team of pattern creators who love crafting, helping you make projects everyone will love. Each issue is themed, with all the patterns you will need in one easy-to-print magazine.

By the time we relax to craft from our busy lives, we find that we want something quick to work on, so we have aimed for each issue to have lots of ideas where you can simply choose what you need and get making. Our ideas for each issue are simple. There are over 50 templates for you to use in your creations, along with some fabulous ideas of how you can use them and tips on how to use them.

In this Embroidery issue the focus is on all things Christmas. We worked on this here in the UK when the sun was shining in June and we were feeling far, far away from the world of mugs of hot chocolate and warm cosy scarves, but time does fly and it is never too early to start on festive projects. Inside this issue you will find a host of different designs from Christmas crackers to cute robins. Show off your stitching with some festive fun, and if you are a beginner we have provided some instructions for basic embroidery stitches to get you started.

We hope the patterns provide you with lots of inspiration. If you have any ideas for future themes, do get in touch at info@jellymediauk.com, we love to hear from you.



Happy Stitching
The Fabulous Patterns Team

Making
Fabulous
memories

Fabulous Embroidery Patterns is part of the *Fabulous* pattern series

www.fabulouspatterns.co.uk

Fabulous Embroidery Patterns is registered at The British Library. ISSN:3049-5563 (Online) **Issue 1, August 2024. All copyright jellymediaUK Ltd.**

No part of this publication may be reproduced in any format or sold by any means without prior written permission from the publishers. Every effort is made to ensure the accuracy of material published in *Fabulous* Embroidery Patterns. However, jellymediaUK Ltd., will not be liable for any inaccuracies. The views expressed by contributors are not necessarily those of the editor or publishers. Photos from Unsplash.



Published by
jellymediaUK Ltd.

Embroidery

for beginners

Embroidery is the art of using stitch to sew a design, which can be abstract or figurative. It can have functional uses, for example making cloth stronger or adding an initial to identify belongings, and/or be decorative for example sewing an attractive flower shape onto a bag.



Photo by Frannie D on Unsplash

There are many different ways to sew embroidery, if you are new to the craft here is some information to help get you started.

Threads

There are lots of different threads available and shopping for them can be very enjoyable! Some of our favourites are:

Stranded Cotton, this comes in a length that contains six individual strands that can be divided. You can use them all together or split them. It is fairly easy to find in stores and is available in lots of colours.

Perle Cotton, this is a twisted thread (so you do not divide the strands) and comes in different thicknesses. The lower the number the thicker the thread (so a size 5 thread is thicker than a size 12). It can come as a skein or balls and is usually a little harder to find than stranded cotton.

Other threads, if a thread can go through the fabric then give it a try. Wool threads can be fluffy and so give a gentle edge to a line of stitching, however they can be thick and therefore stand out more from the backing fabric. Silk can be luxurious to work with and have a lovely sheen in the light.

Needles

You can buy embroidery needles in packs containing different sizes which are ideal if you are just starting out as it means you can try them and see what works best for you. If using thicker thread you can also try Chenille needles as they have a larger eye which makes them easier to thread but also a sharp point to help them smoothly go through the fabric.



Marking Tools

There are lots of different products available. If you are going to be sewing over the drawn line then a very light pencil can be work well, otherwise look for ones that you can remove such as chalk or water-soluble pens (always read the instructions before starting and test to make sure it can be removed). If working on dark fabrics then tissue paper can be useful as you can mark the design in it then tack it to the front of the fabric, embroider through it then carefully remove it at the end.

Fabric

You can sew embroidery onto any fabric you can get a needle through, however some work better than others. When starting out choose a fabric that does not stretch, such as a cotton. It can be trickier to sew on thinner fabrics so look for something with a bit of body to it. Old clothing and household textiles, such as tea towels, can be perfect for working on when you are learning. If you want to work on fabrics that stretch, such as a jersey t-shirt, it is a good idea to use some stabiliser (available from sewing supply shops) to ensure a good result.

Hoop

An embroidery hoop keeps the work taught so the fabric does not gather up as you sew. This means the finished result is much more likely to be nice and flat. Ideally, your hoop is slightly bigger than your design so you can fit the whole design in and do not need to move the fabric. We love our seat frames so if you enjoy embroidery you might want to put one of these on your wish list.

Design

The templates in this magazine are all provided as line drawings. With these you can:

- Sew along the lines to create an outline design.
- Fill in the motifs with stitches to create areas of pattern.
- Use stitch to fill in the shape.

For an alternative look you can also fill in all the space around the design instead, leaving the space inside the motif blank.

Using the Templates

Method 1

Print the design onto paper then use masking tape to hold the paper at a window. Place the fabric on top right side up, tape into position, then trace along the line. If using tissue paper simply place on top of the printed design and trace using a softer pencil so it does not drag the paper, then pin or tack to the front of your fabric.

Method 2

Print your template and use a glue stick to attach it onto a piece of card (this can be some old packaging out of the recycling bin). Then cut out along the line using paper scissors, place the card on the fabric and draw around it. If there are areas within the design to be marked do these by eye, or make additional templates.

Tip

When using the template you may need to reverse (mirror) the design depending on how you want the motif to look. This is especially important when working with designs that cannot be mirrored, such as text.

Embroidery

Guide to basic Embroidery Stitches

1 Running Stitch

This is great for going around the side of a shape. Simply take the needle in and out of the fabric working along the line. You can try to make the stitches small, long or even vary them (so one small stitch followed by one long).

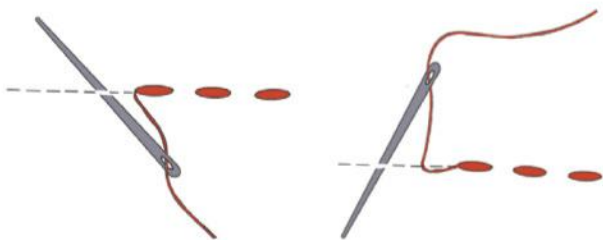

Interlaced Running Stitch

Thread a blunt needle, such as one for tapestry, and lace a thread under the running stitches.



Stitch Variations

You can use this stitch to lightly fill in areas.

Cross Stitch

Create little crosses, these can be as large or small as you wish

Seed Stitch

Small stitches to create an effect like rice being scattered on a surface



Stitch Variations



Cross Stitch

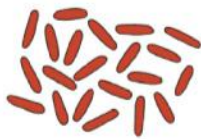

Seed Stitch

2 Back Stitch

This creates a solid line. To start, bring the needle to the front and make a stitch. Then take the needle to the back and travel a little way forward along the line. Bring the needle to the front of the fabric then stitch back, going through the hole it has come out of, and repeat along the line.



3 Split Stitch

This works best with stranded thread as it splits easier than a thread that has a twist. Take a stitch, then bring the needle from the back up the front halfway through the previous stitch, this 'parts' the thread. The travel along to take another stitch and repeat, bringing the needle back up to the front halfway along the previous stitch.



4 Chain

This can be worked in different ways, for example as shown here along a line but the stitches can also be made individually or even in a row which each stitch facing up and down, like a zig zag. To start, bring the thread out at the start of the line and use your thumb to hold it. Bring the thread round and put the needle back into where it has come out of then bring it back to the front a short distance forward. This will catch the little loop. Repeat.



5 Satin Stitch

These are straight stitches are worked next to each other to create a block of thread.



6 French Knot

Bring the thread to the front, hold it between your fingers and twist it around the needle once or twice. Keep holding the threads (the tension is important) then take the needle back through the fabric just next to where it has come out. Gently pull the thread through and it should create a little knot.

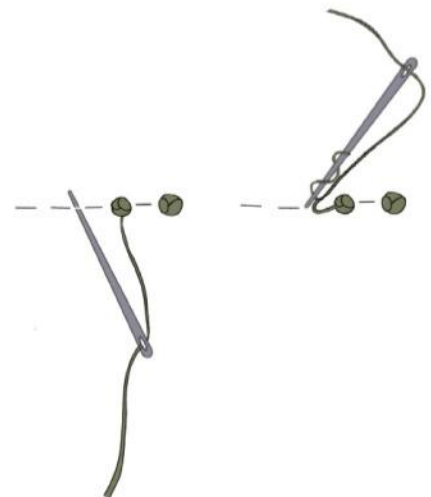

7 Couching

Lay a thread (or several threads, or even something thicker such as string), along the line to be sewn with your thumb. Then take small stitches over it at regular intervals to hold it in place. To neaten the ends of the thread being couched take them to the back of the fabric and secure.

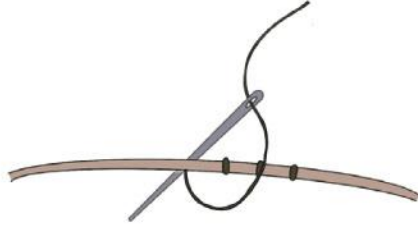

8 Fly Stitch

These can be made detached like these, or in a row closer together. Use your thumb to hold the loop of thread in place then insert the needle back next to the place it has come out of the fabric and back up the front of the line to hold the loop and make the stitch.



Tips for Beginners

- Print out the design several times and take some pens or pencils and doodle on it. This will give you an idea of where you might want colour and pattern and is a way to try things out before spending time stitching.
- Create a practice cloth for stitches. You can stitch these freely on the cloth or draw a grid pattern of little boxes to fill in.
- Try mixing different thread types and weights for an interesting effect.
- If you are working on a large piece make sure you keep the packaging for the threads so if you need to buy more you can get the exact same colour.
- If you are going to be washing your finished item read the packaging that comes with the fabric and threads beforehand to make sure this won't be a problem. If you do not have any packaging for example, you have bought threads from a charity shop, then do a test piece.
- Take your embroidery out of the frame when you are not working on it, especially if for a few weeks, to avoid getting hard to remove creases. When finished iron the piece from the back, try not to flatten the design. You can lay it right side down on a towel which helps prevent the stitches being flattened.
- There are hundreds of embroidery stitches and you can find them in books (we love vintage ones), and on social media where there are plenty of videos uploaded by people sharing their favourite stitches. One online resource we particularly love is the Royal School of Needlework RSN Stitch Bank. The charity set this up to mark its 150th anniversary and their website features illustrations and videos of lots of different stitches, information on their usage and history, and the stitch resources can also be flipped so you can get instructions whether you are right or left-handed.

Placement Ideas

Some ideas of things to make from your embroidery designs:

Picture – place your work in a frame. Box frames work well as the glass has a distance between itself and the embroidery. You can also display your work in the hoop, which can be decorated such as by painting it.

T-shirts – take a plain t-shirt and add a design on the front, back or even the sleeve.

Clothing – use a design to help darn a hole and add some interest. You can also embroider onto a pocket and add this to a garment or even stitch a piece of scrap fabric then sew this on.

Tote bag – if you have some old freebie tote bags in the cupboard adding embroidery to them can be a good update.

Oven gloves and tea-towels – don't throw them away when they have a scorch mark or stain, stitch over them with embroidery. You can also buy some plain ones and personalise them for family and friends.

Table mats and coasters – these are fun to make and a quick way to display stitching and make something unique for the home.

Wash bags and glasses case – these are items many people use daily and so a nice item to use stitch to add a personalised touch.

Bunting – if you want to try out lots of different embroidery designs then displaying them as bunting is great for this as each pennant can be different. They also do not have to be triangular, they can be semi-circles or square and a mixture of sizes.

Greetings Card – stitch onto a piece of fabric and cut this slightly smaller than the piece card and glue onto the backing (double sided sticky tape can be good for this).

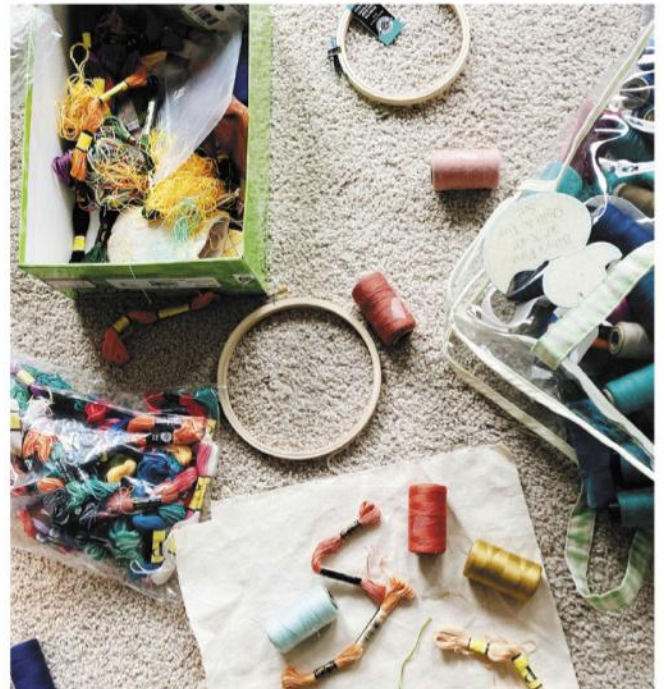

Photo by Casey Chae on Unsplash

Here are some ideas of how to use one, or more, of our original sewing patterns. Brighten up a tote bag or a tired t-shirt, make a magical card for a loved one or make a picture to frame as a memory on your wall.









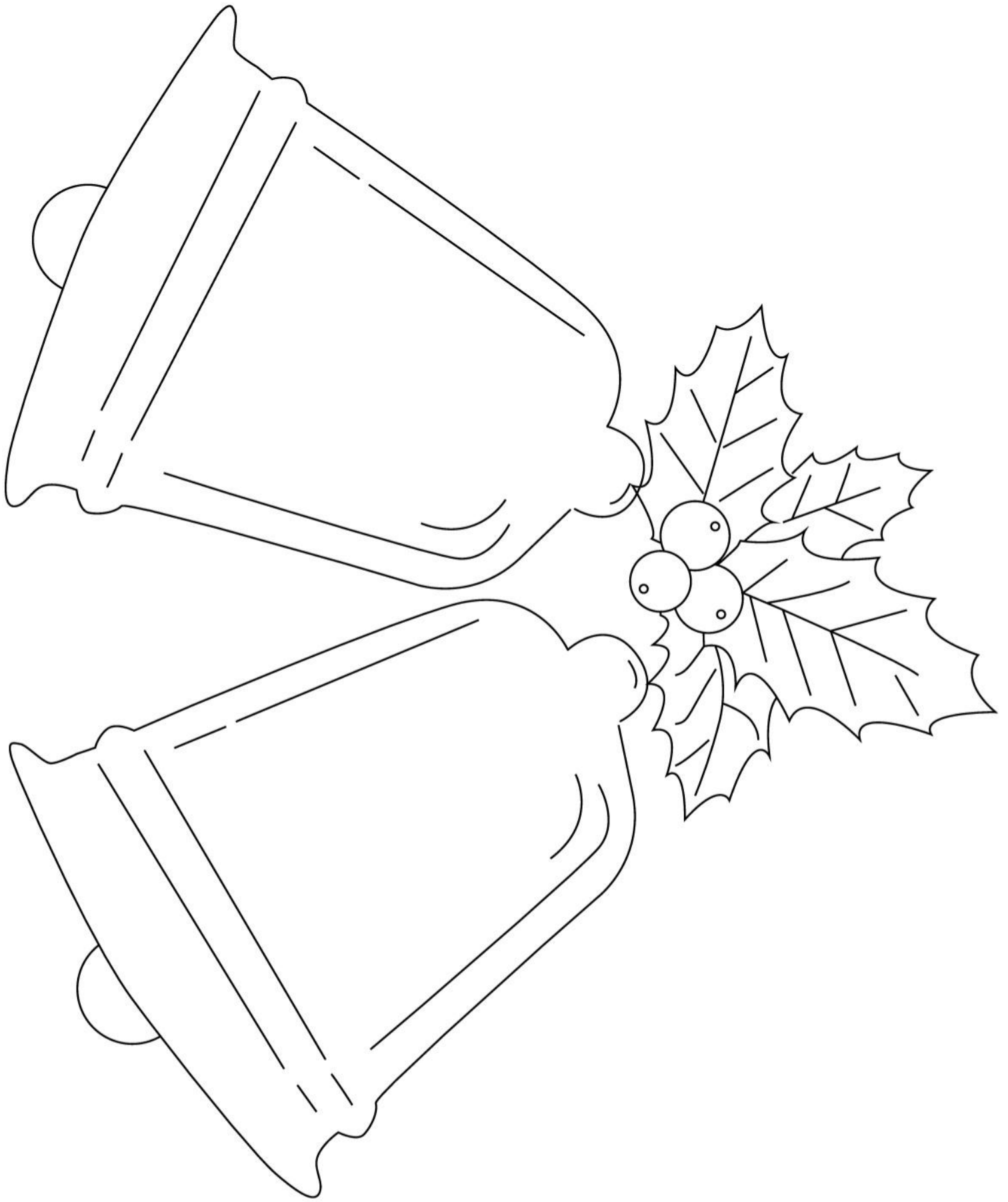

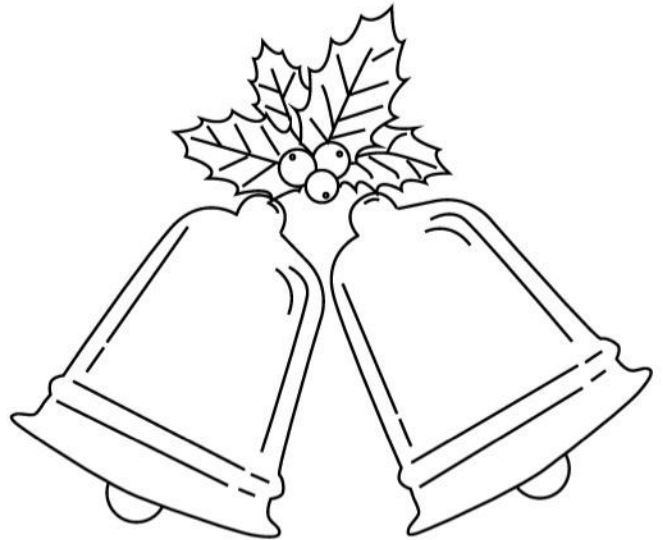
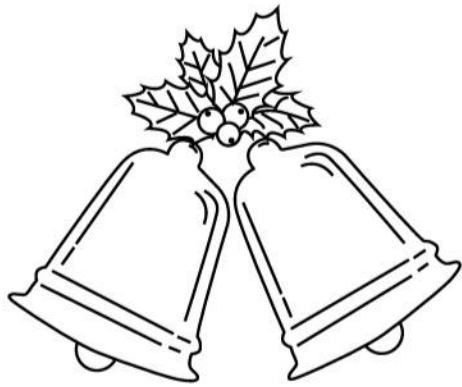
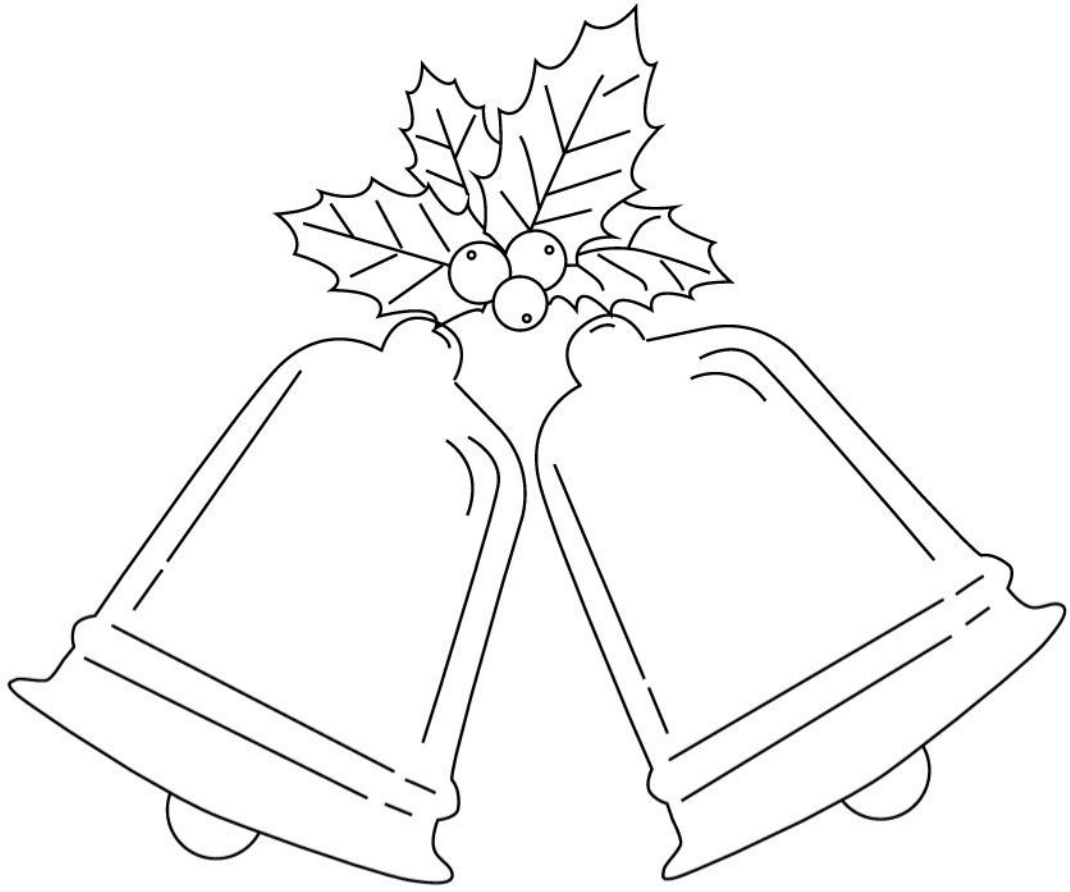

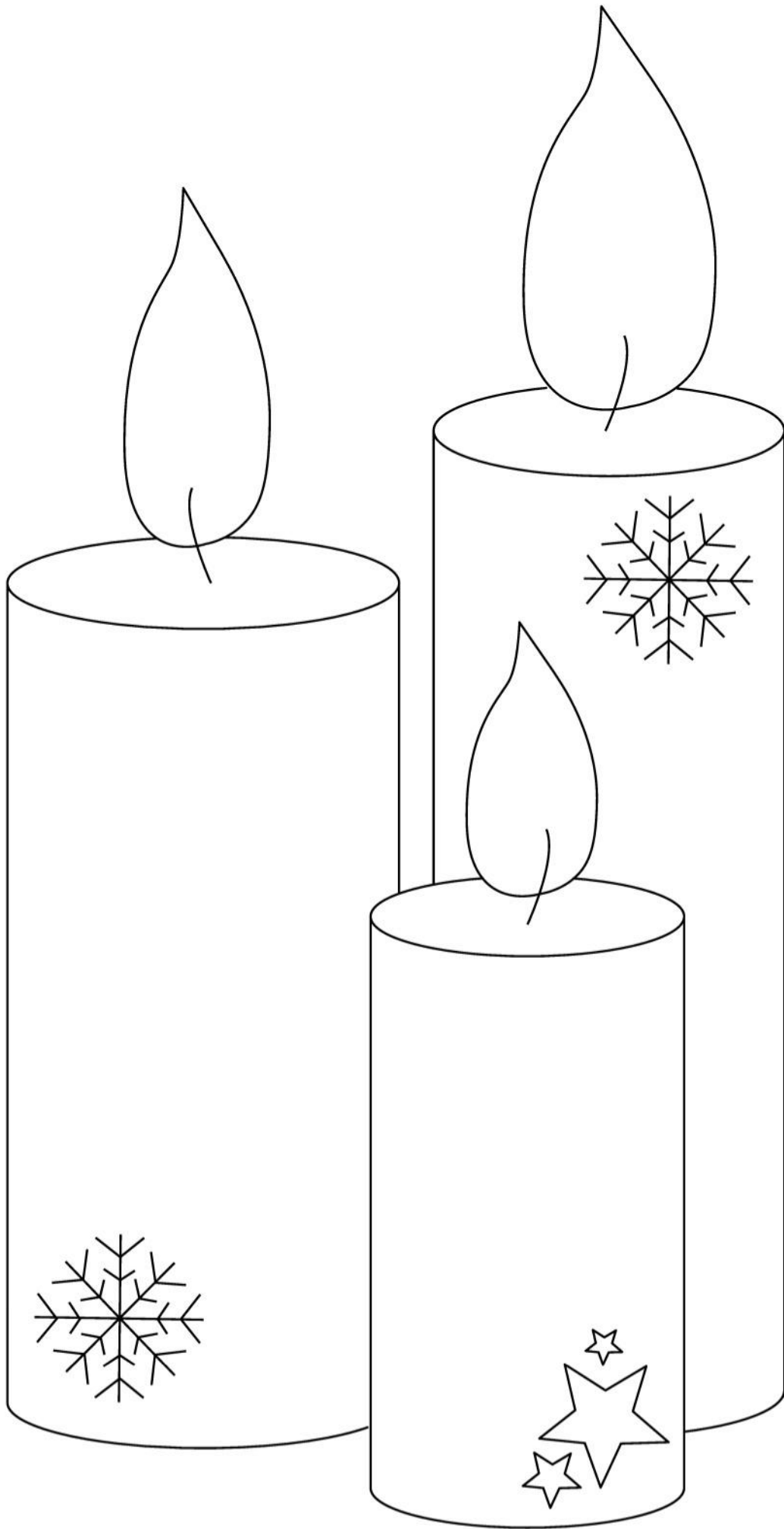

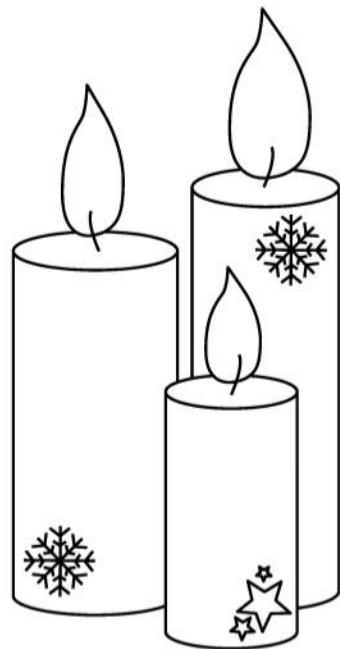
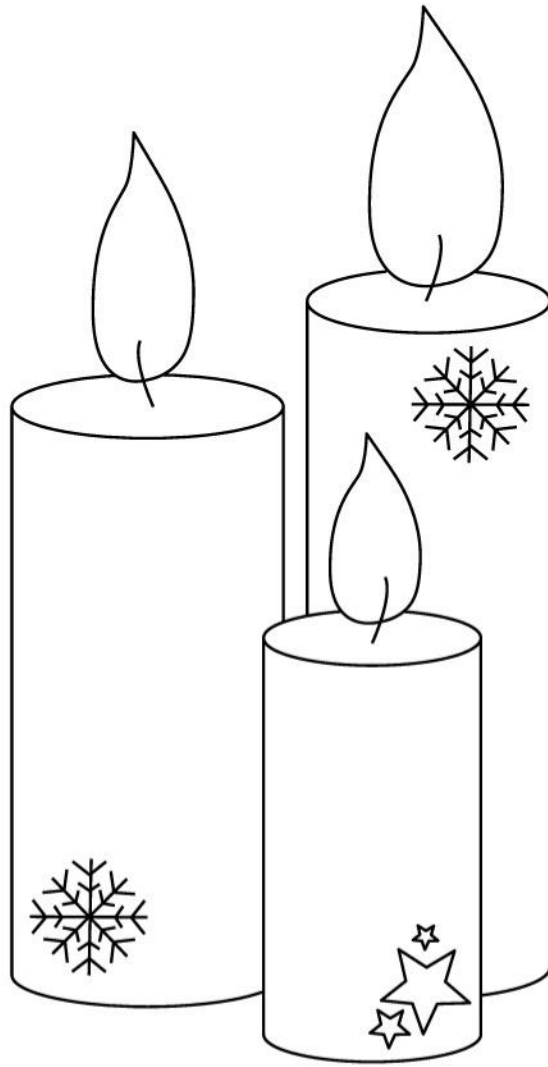

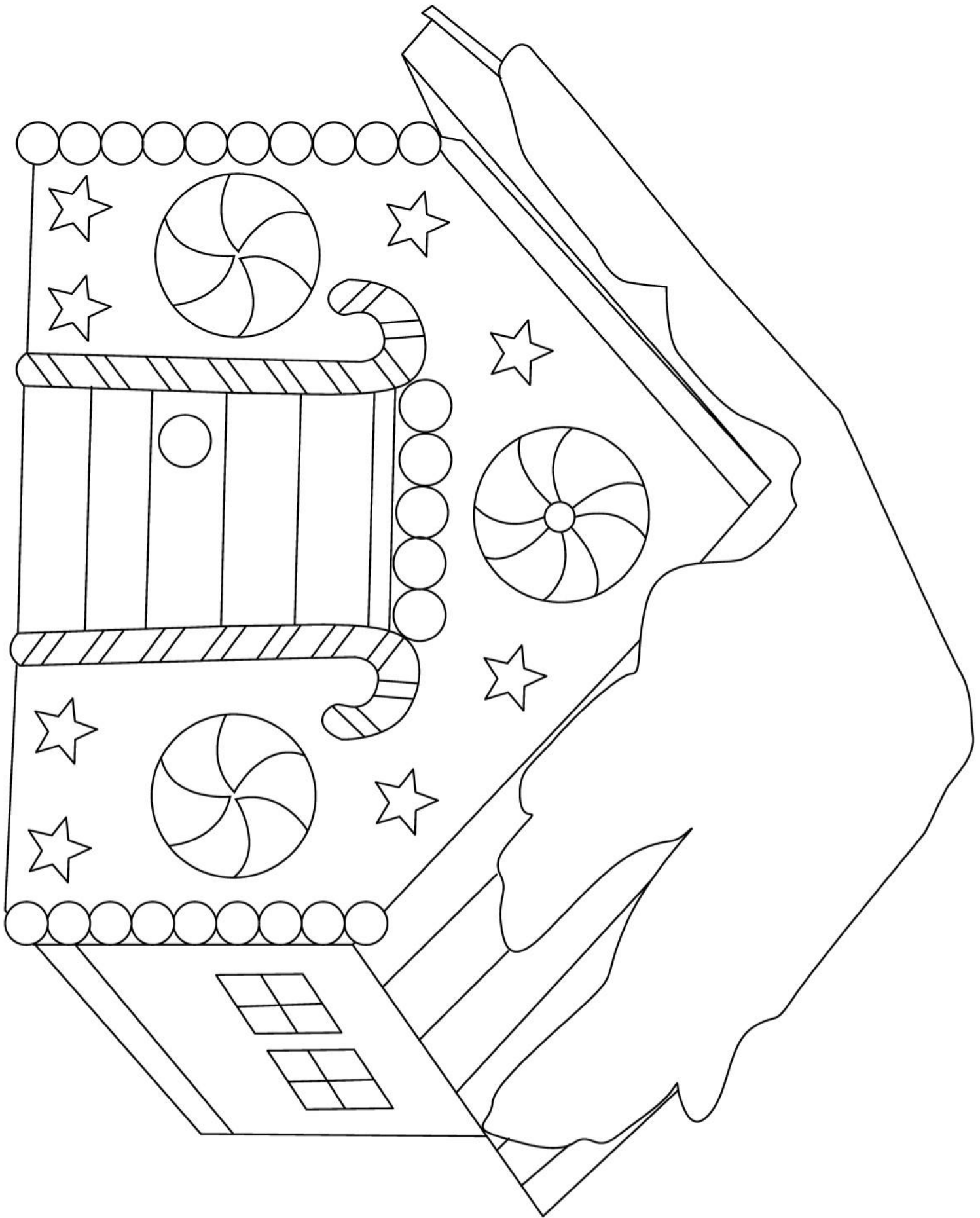

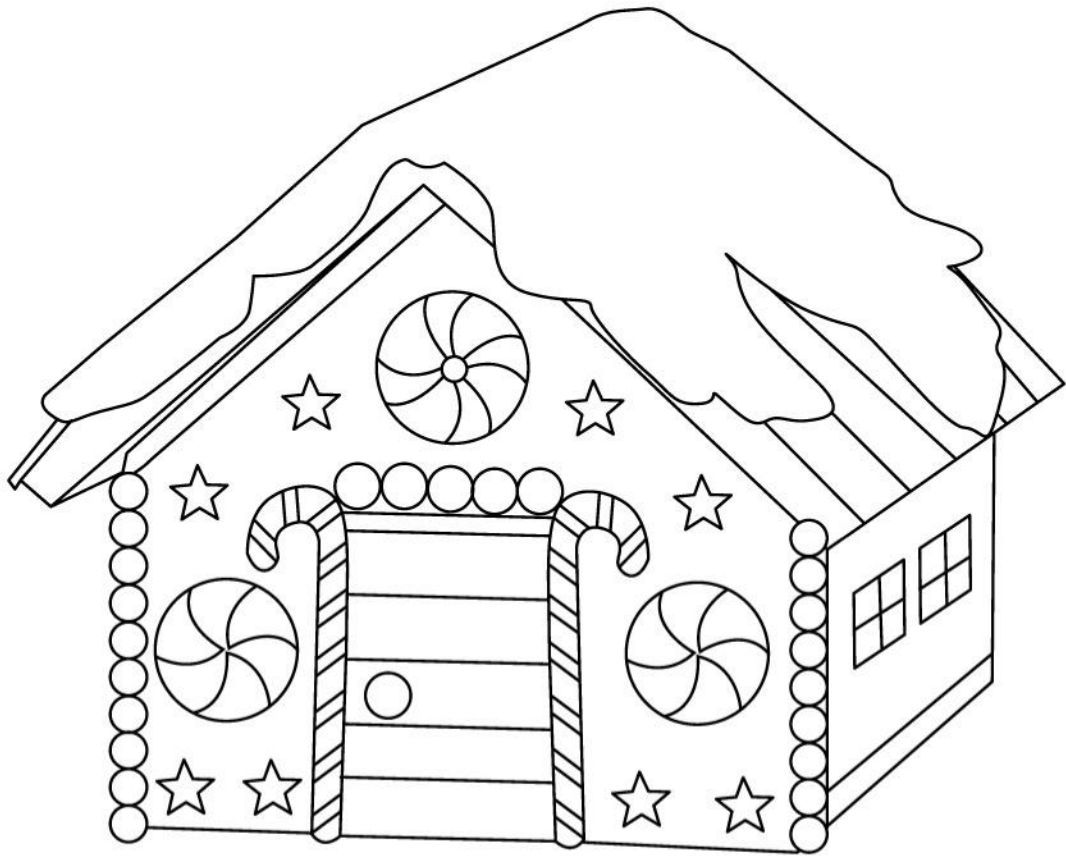

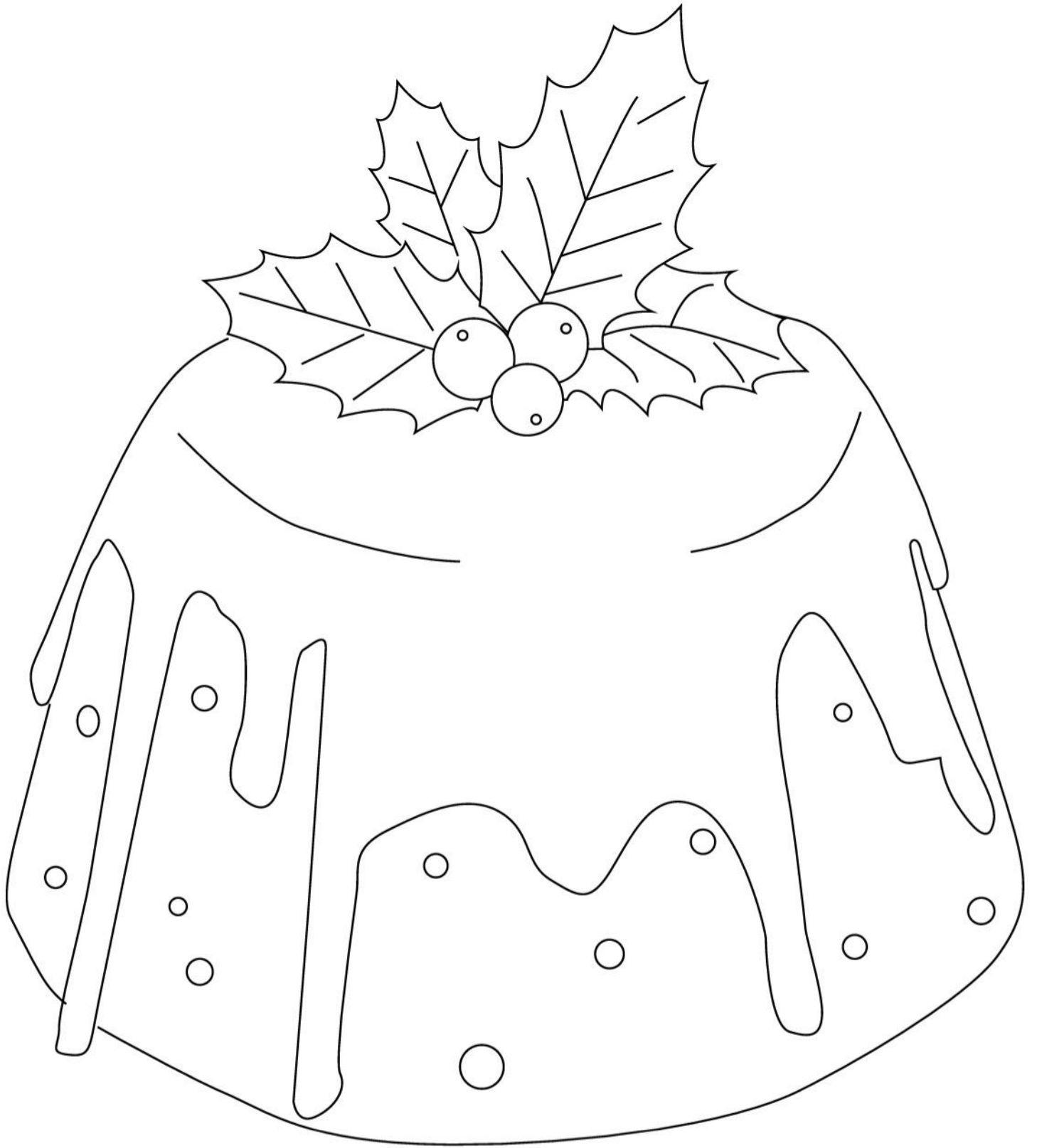

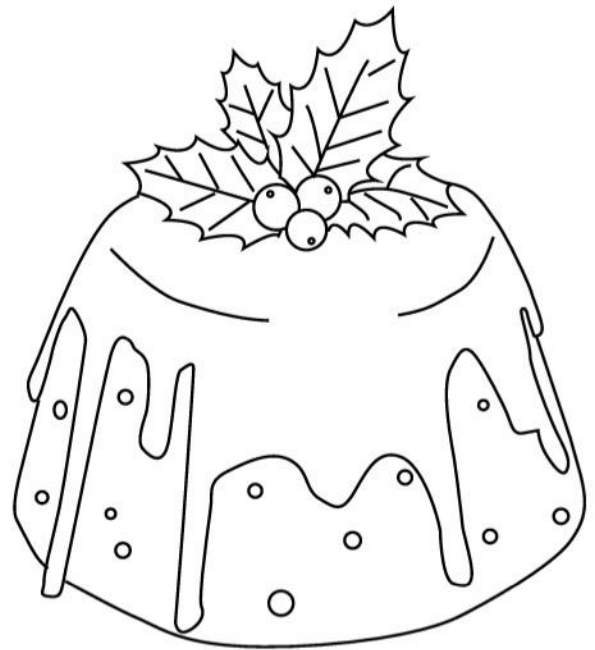
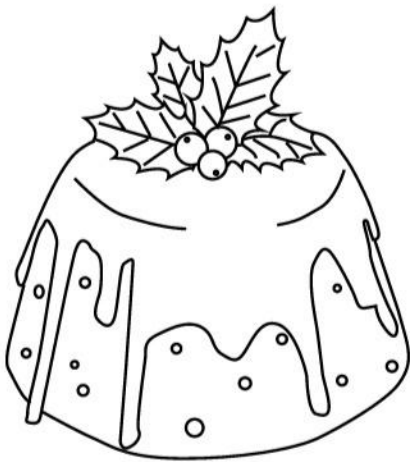
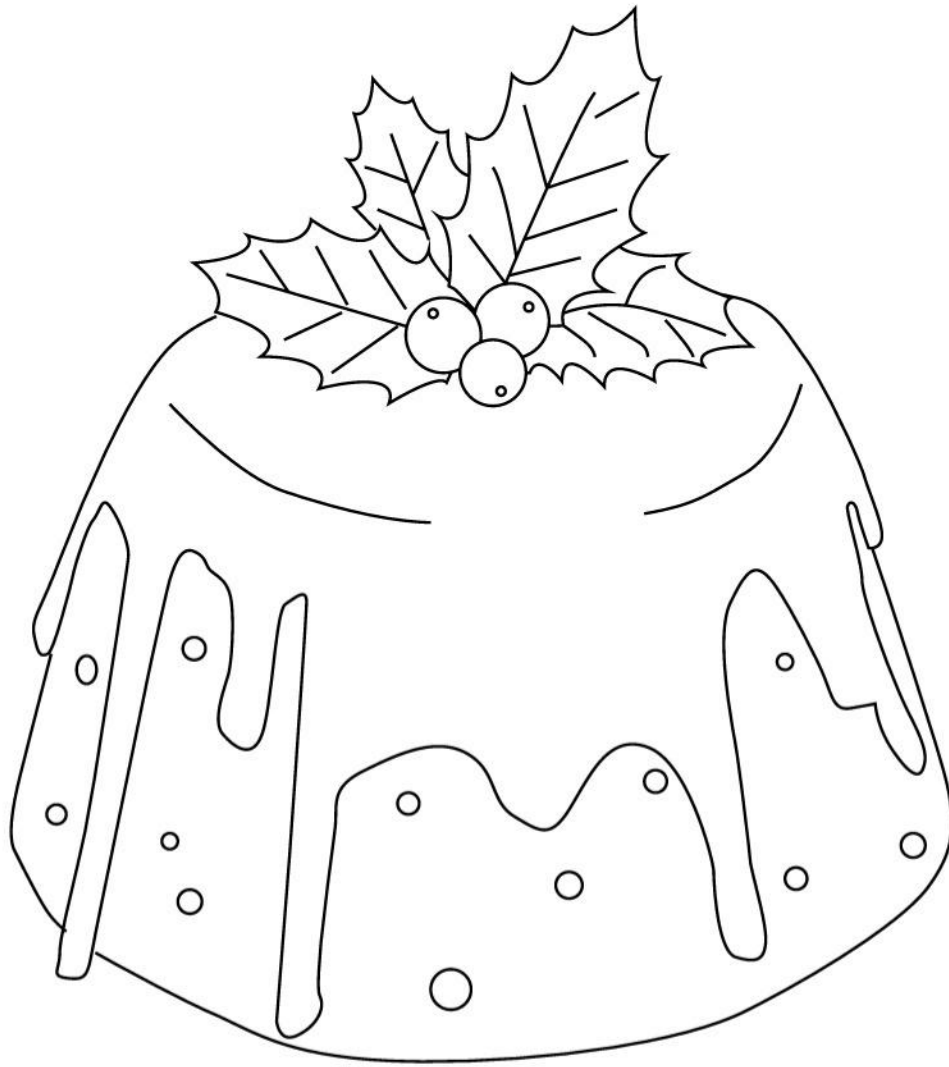

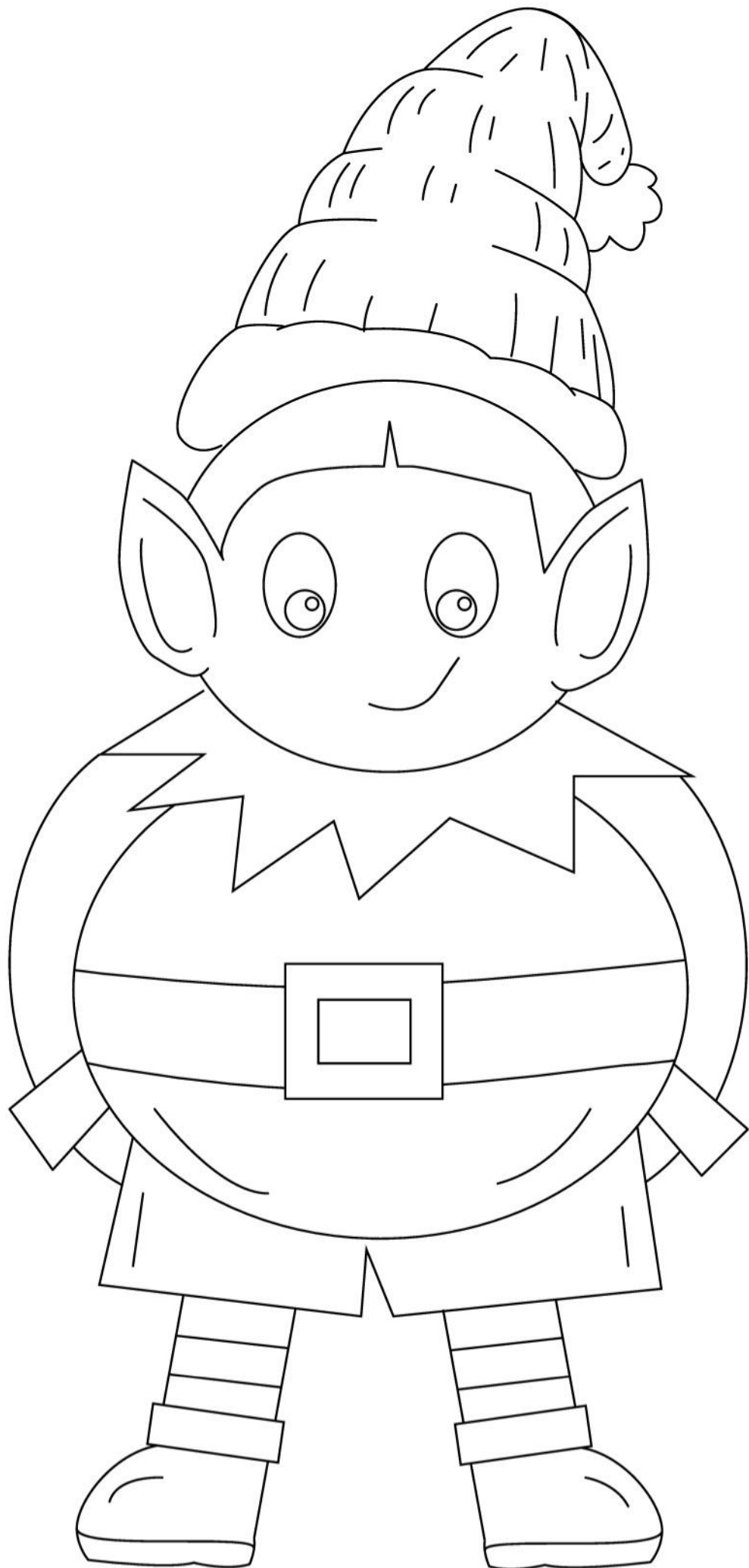

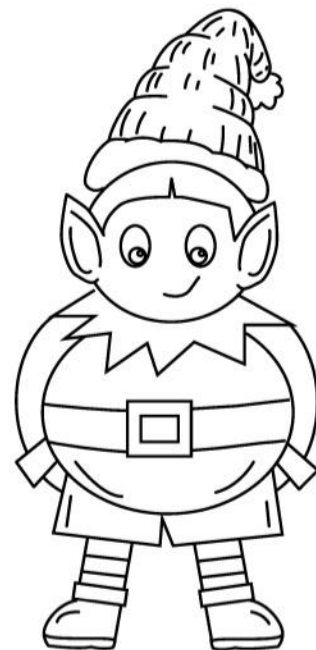
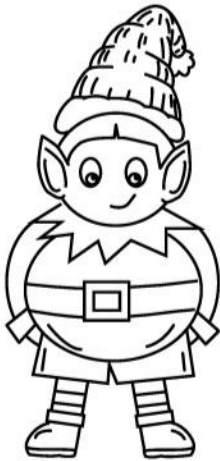
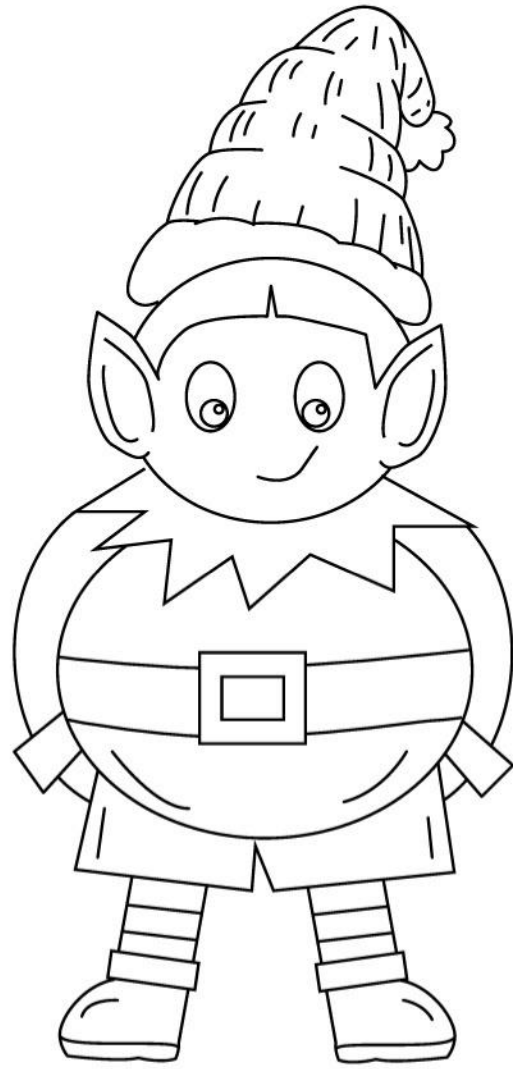

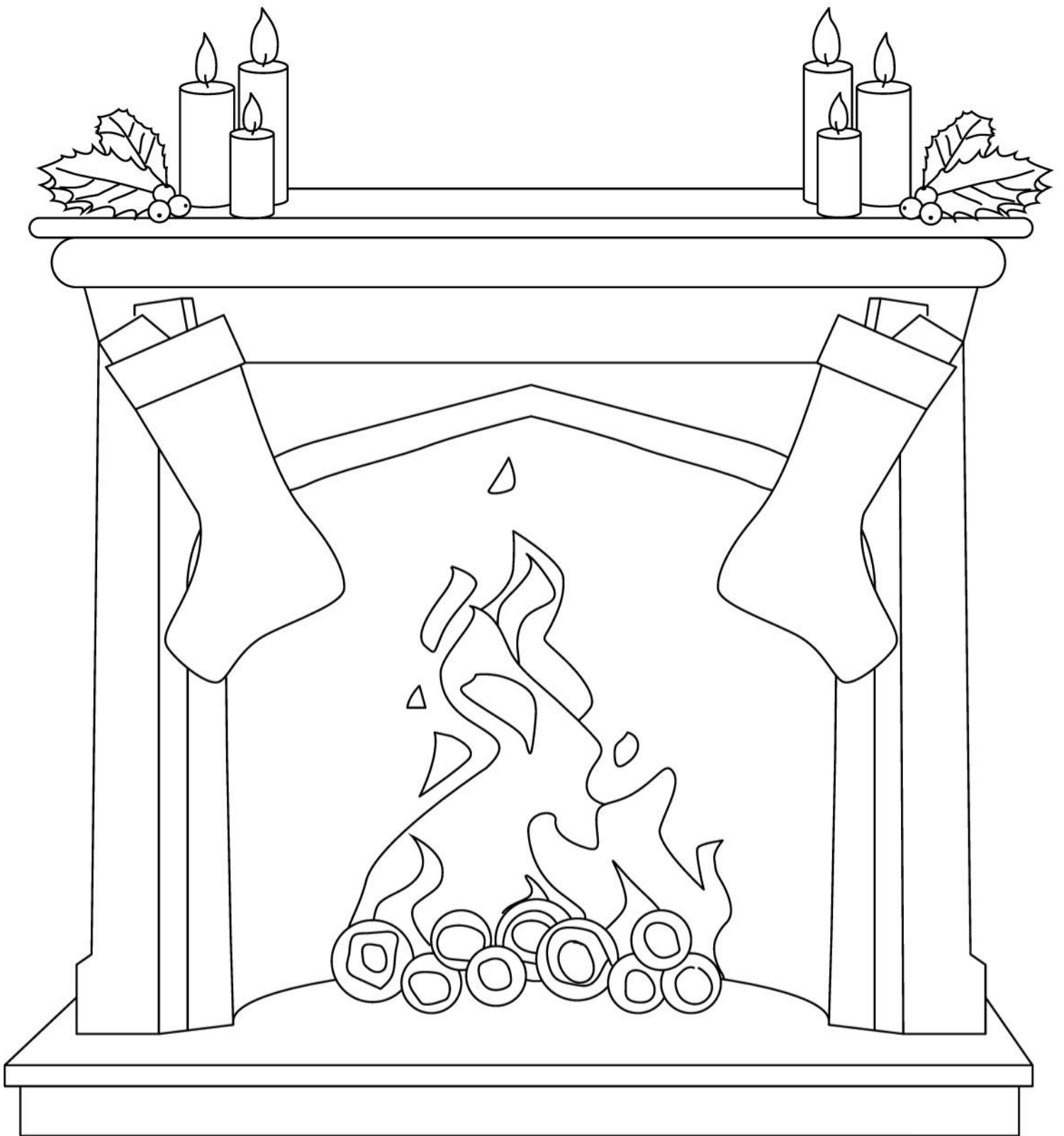

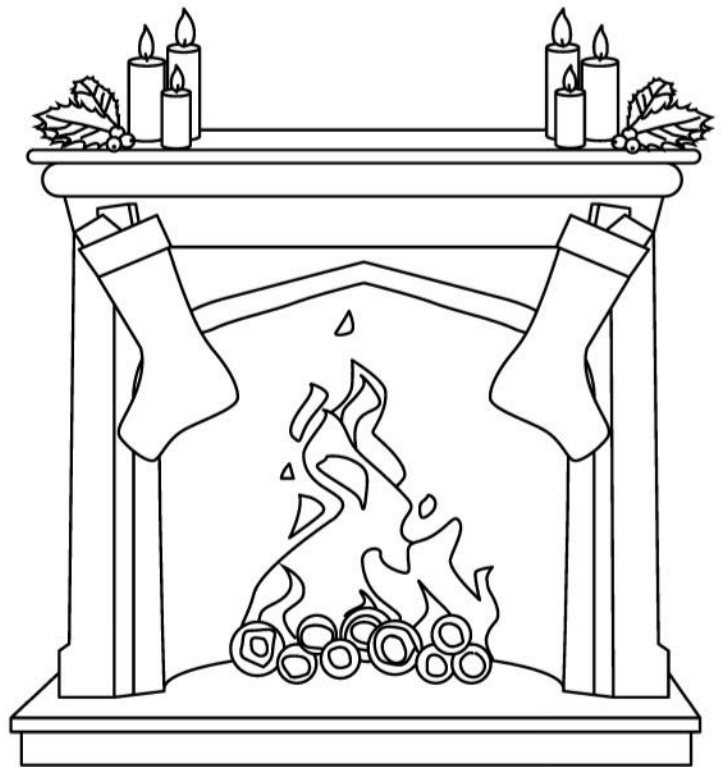
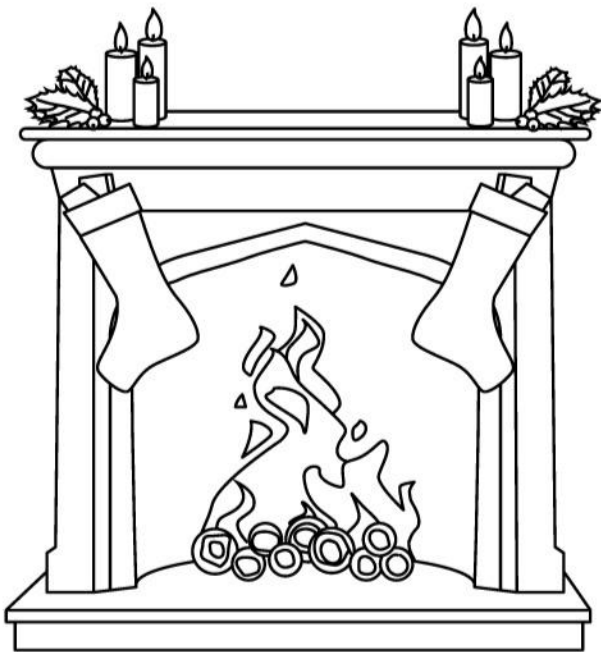
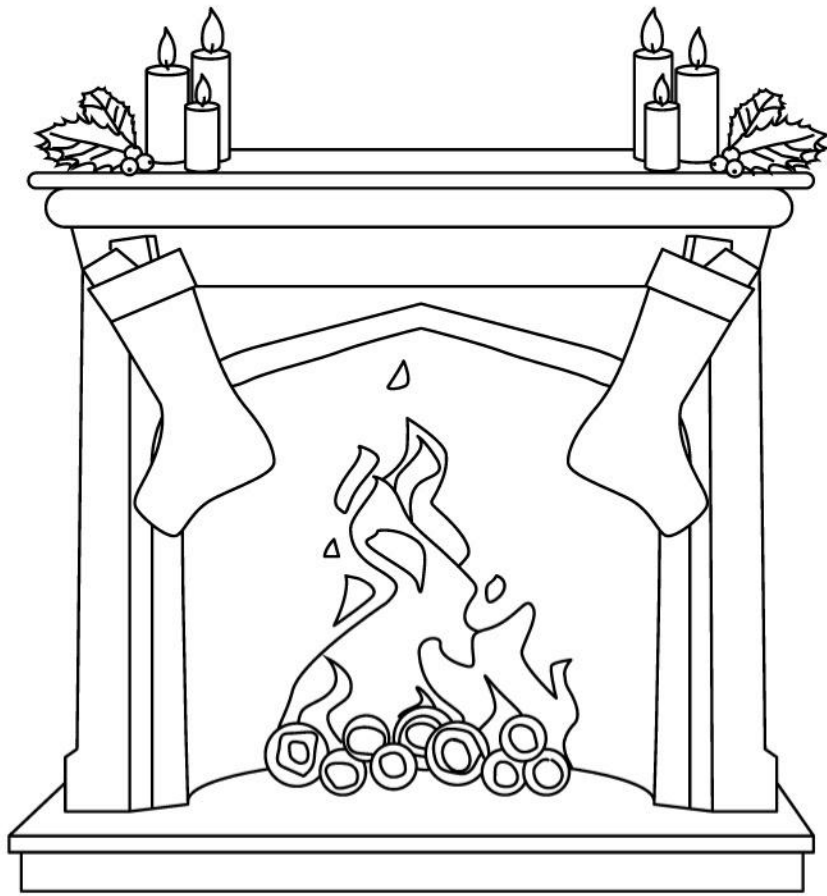

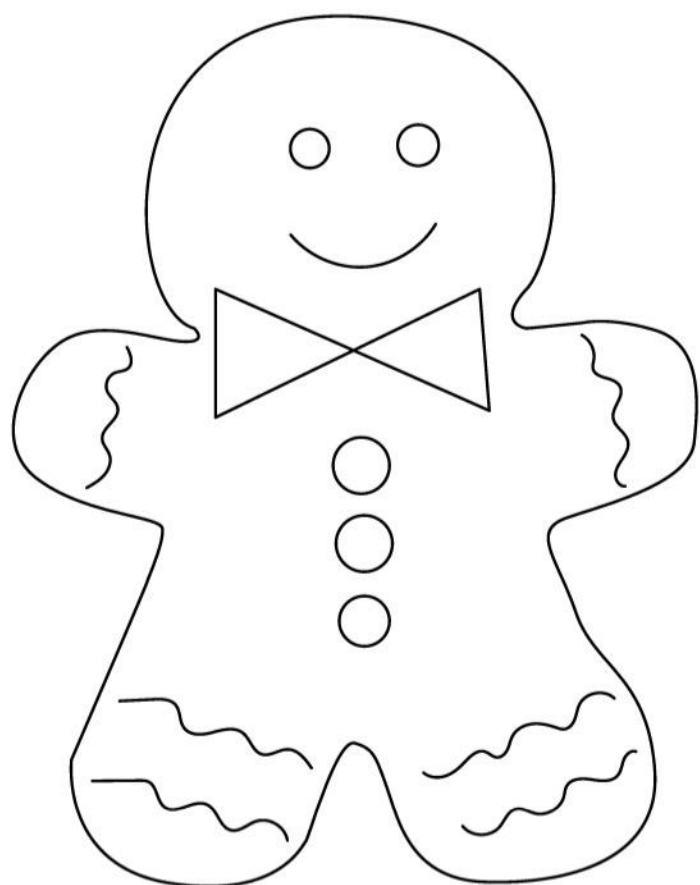

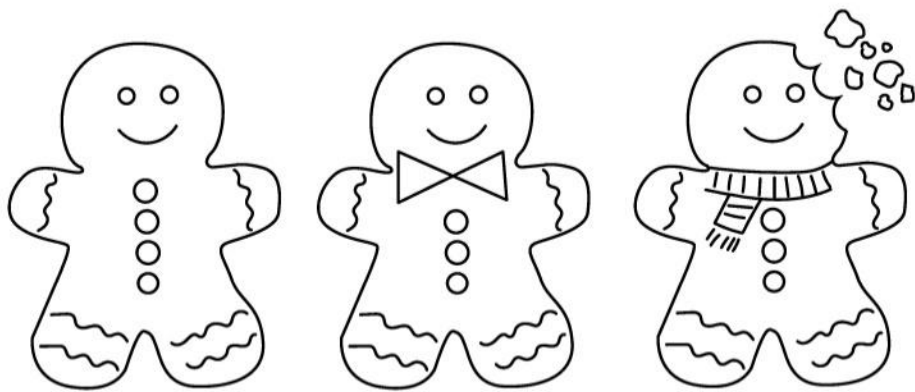
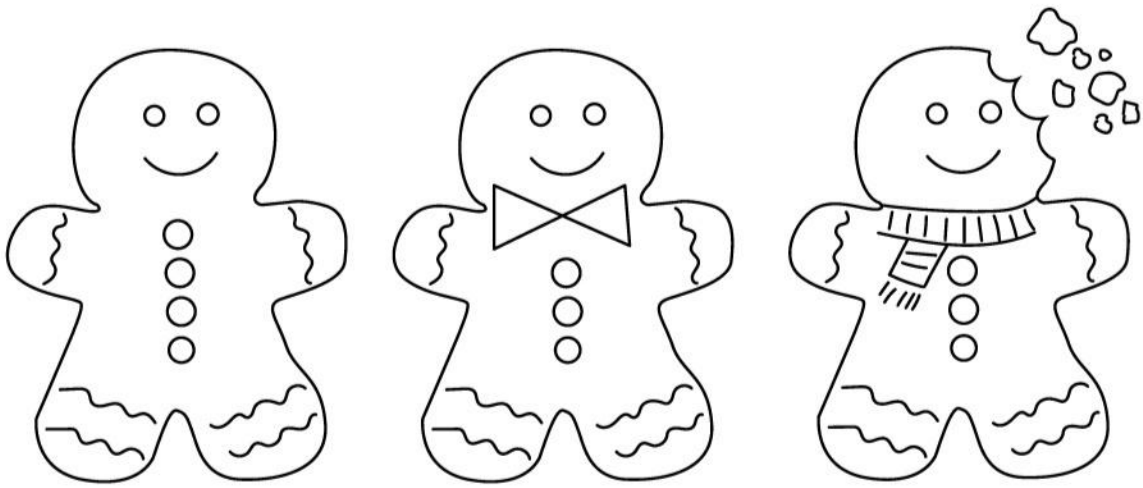
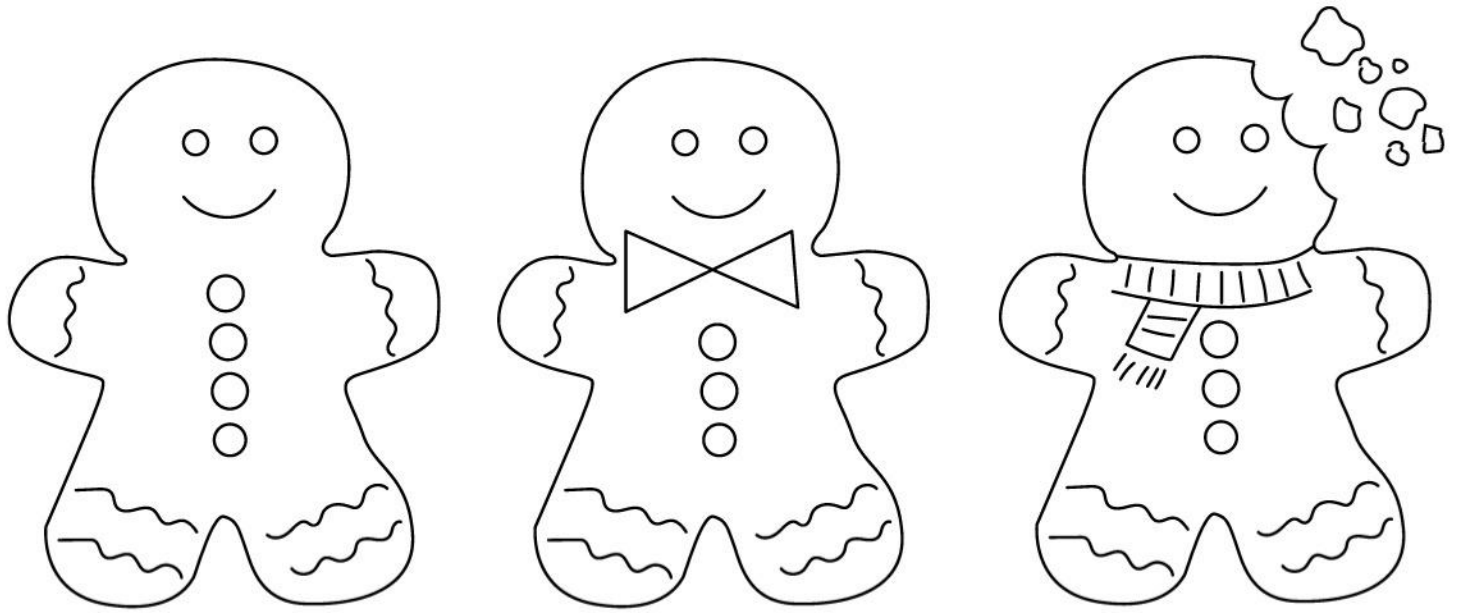



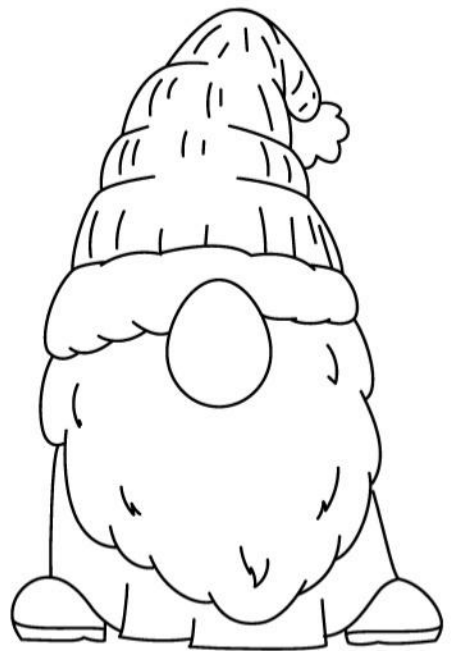
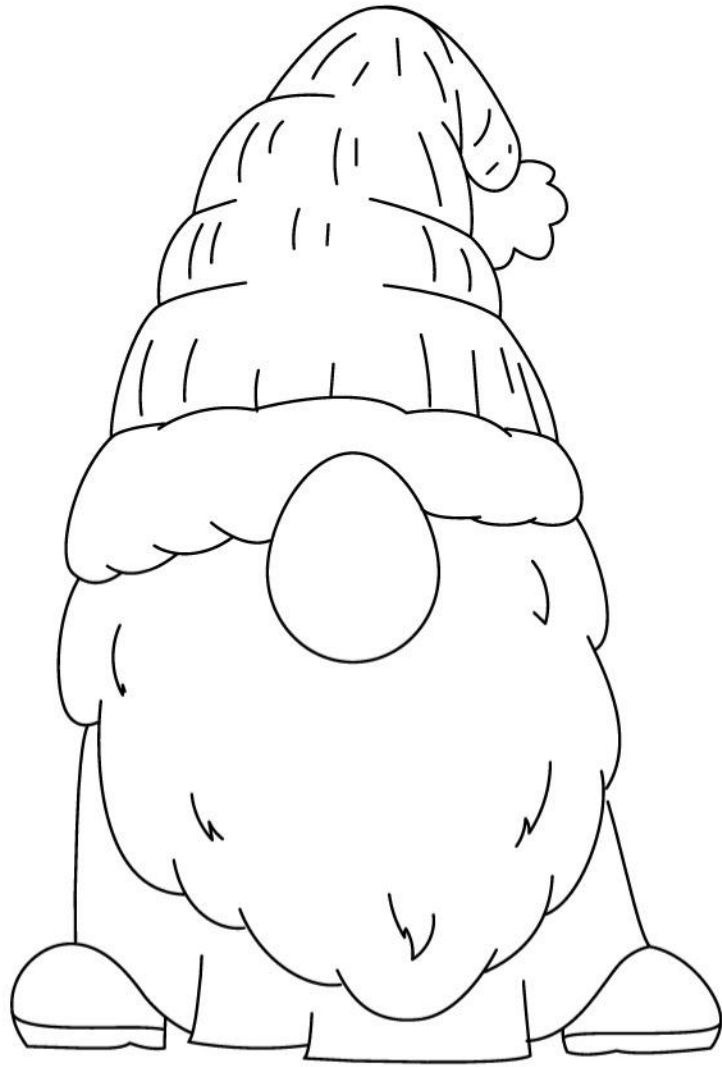

HO HO HO

Merry Christmas

!! Merry
Christmas

Festive Cheer

Santa Stop

Here

HO HO HO

Merry Christmas

!! Merry

Christmas

Festive Cheer

Santa Stop

Here

HO HO HO

Merry Christmas

!! Merry

Christmas

Festive Cheer

Santa Stop

Here

HO HO HO

Merry Christmas

!! Merry

Christmas

Festive Cheer

Santa Stop

Here

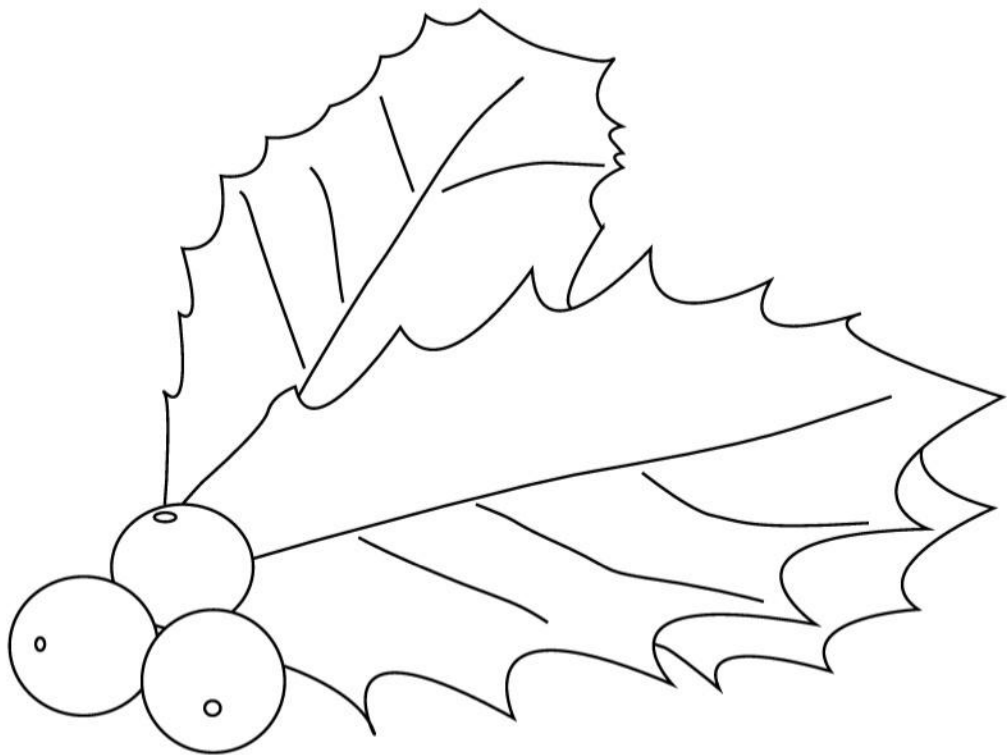
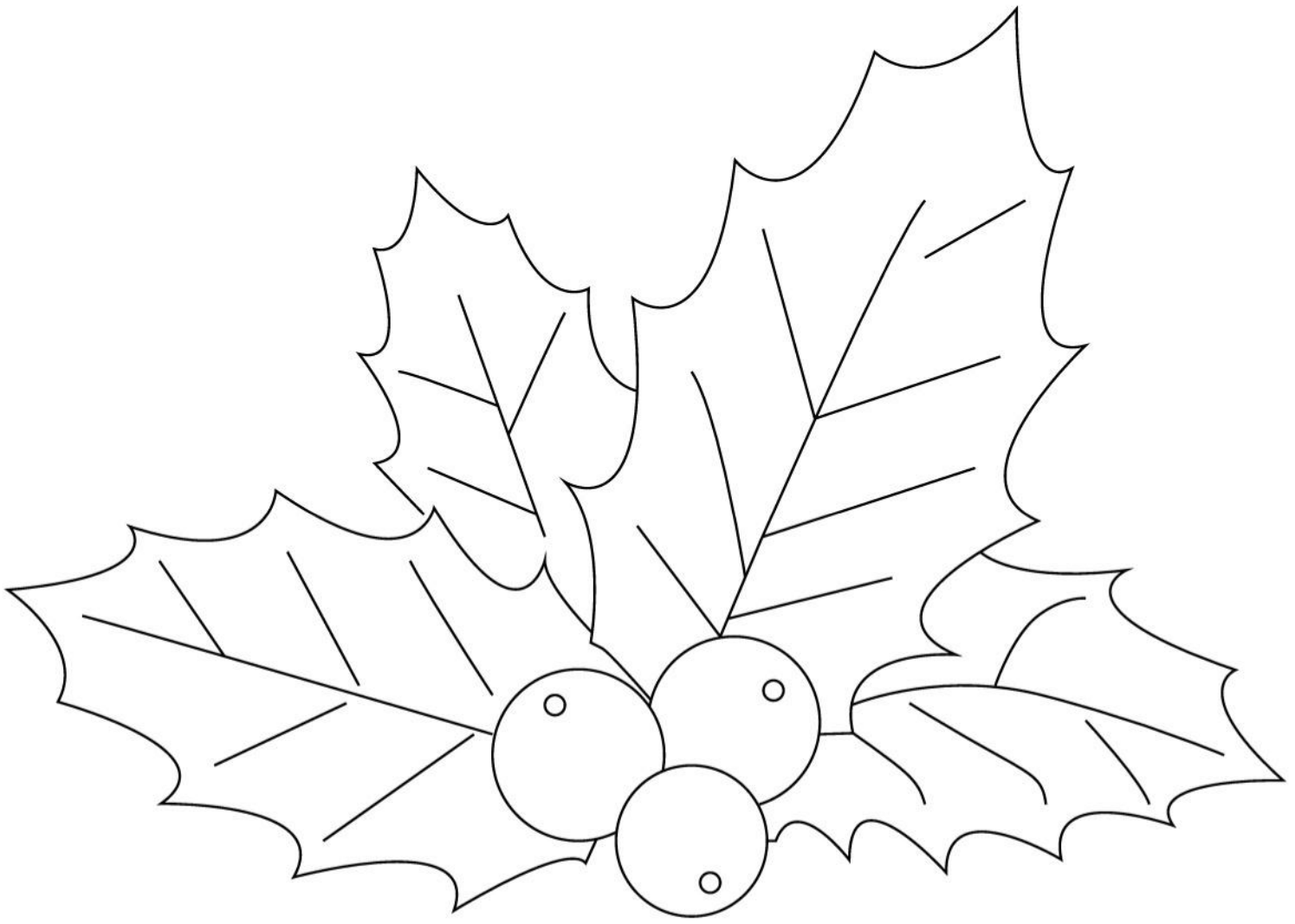

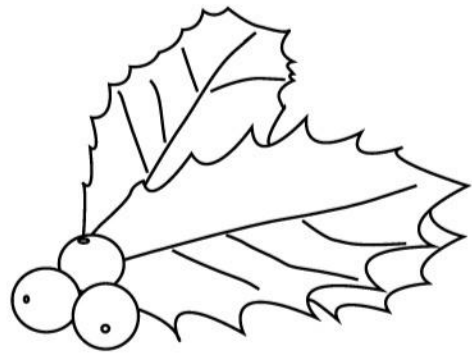
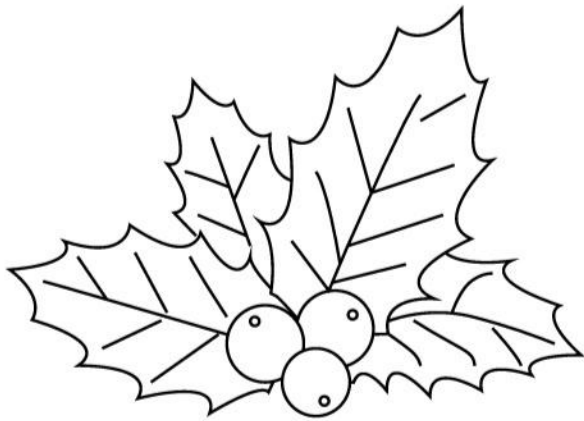
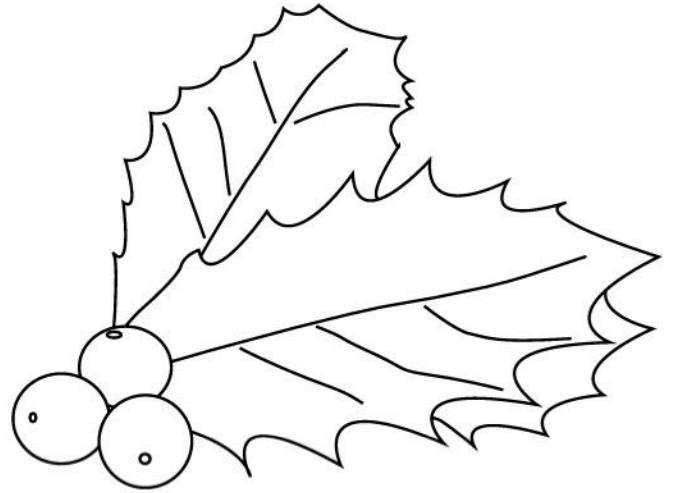
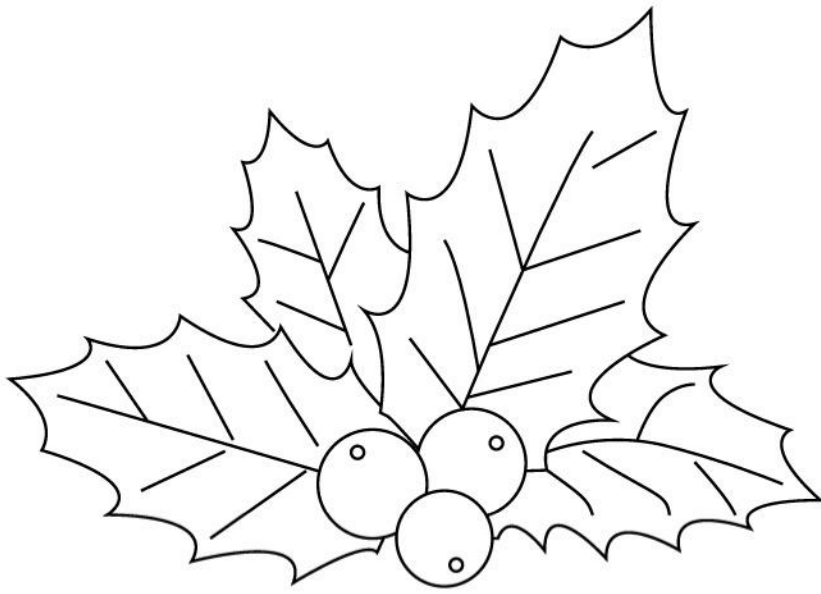





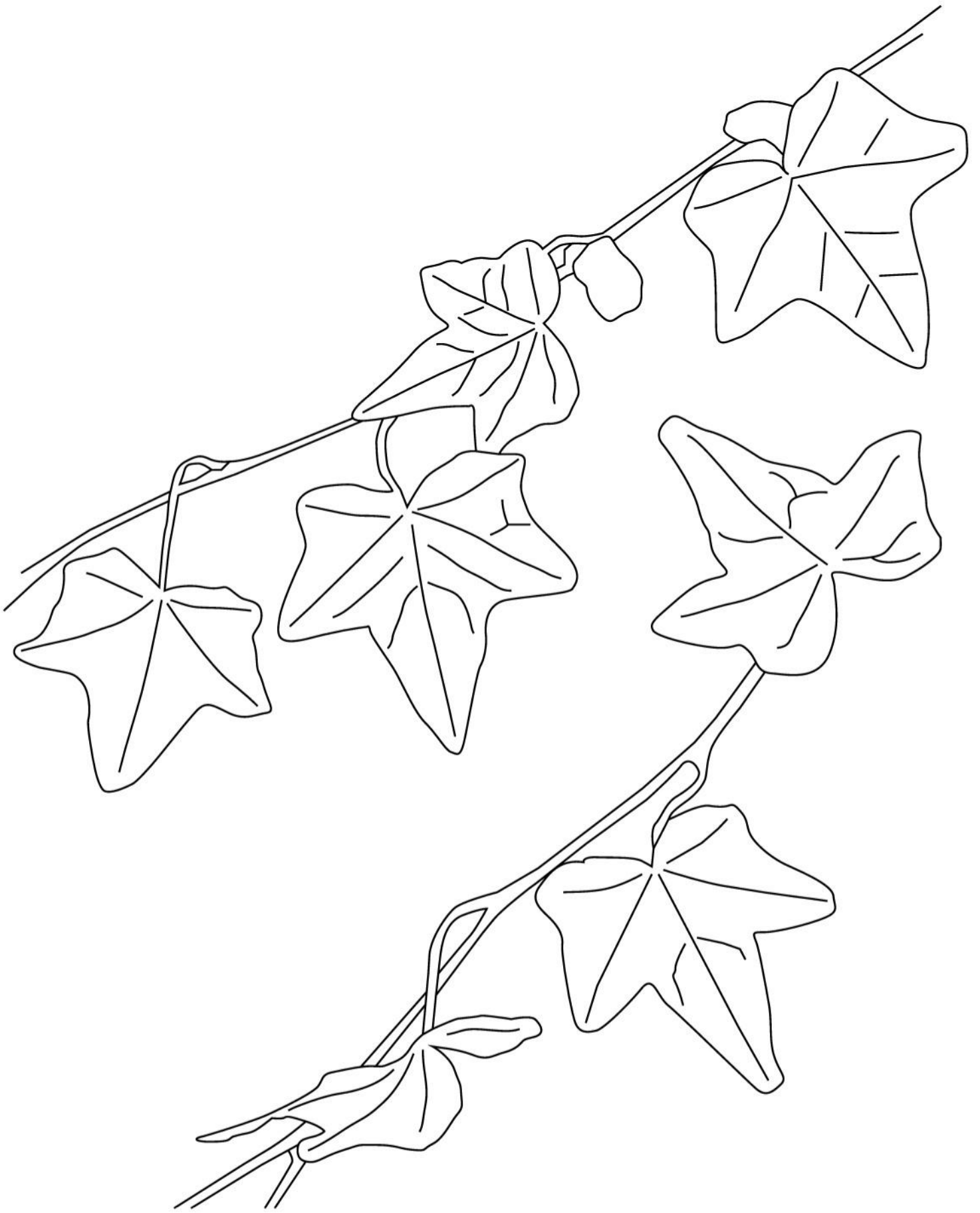

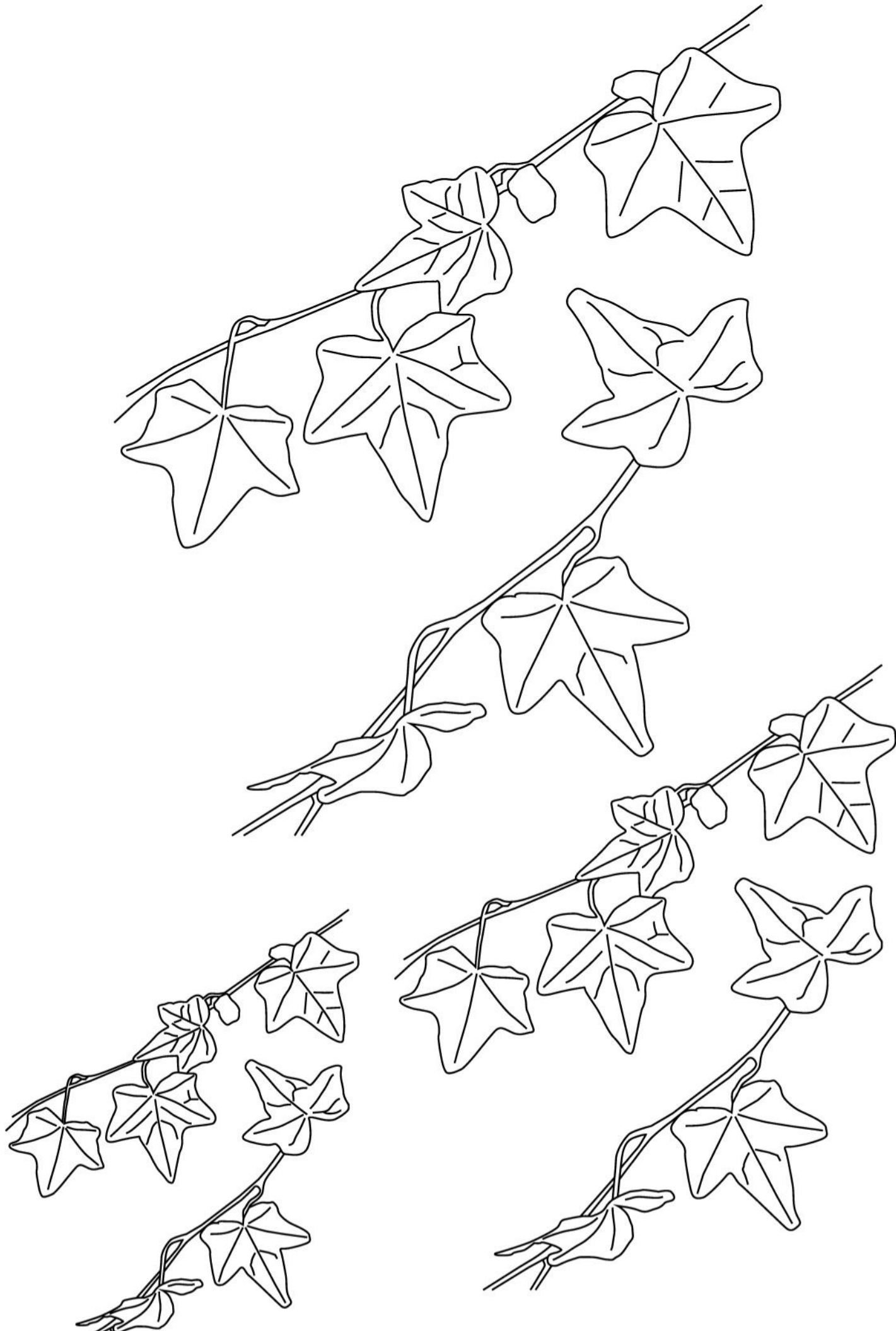

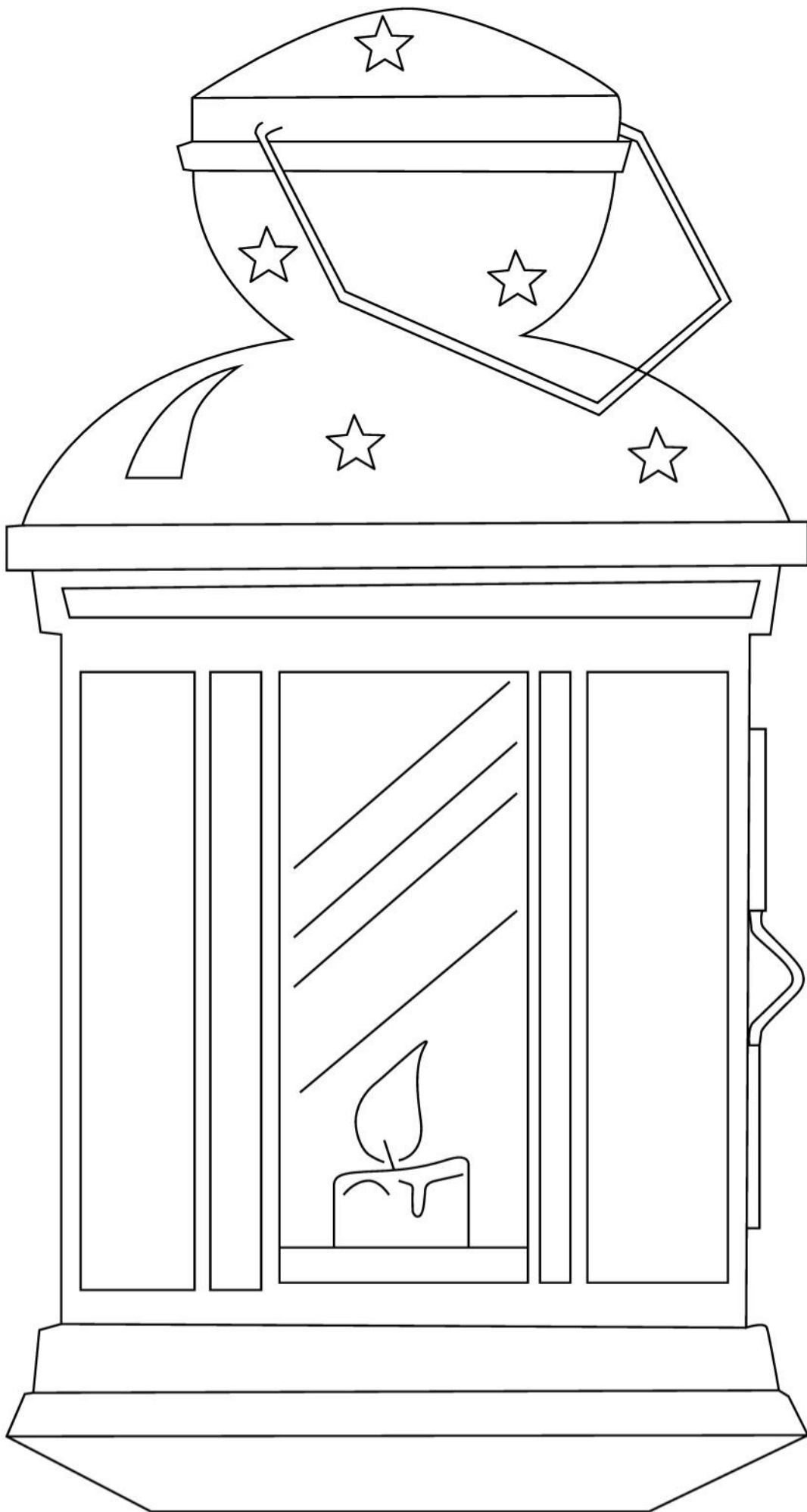

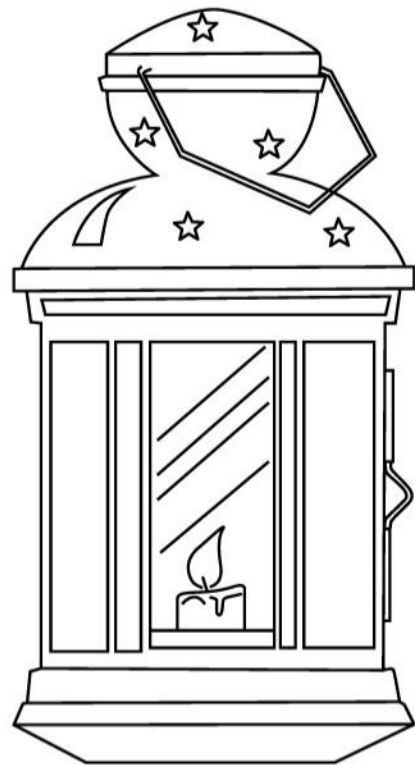
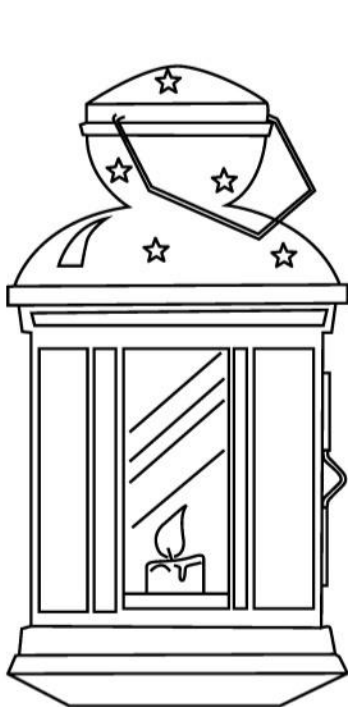
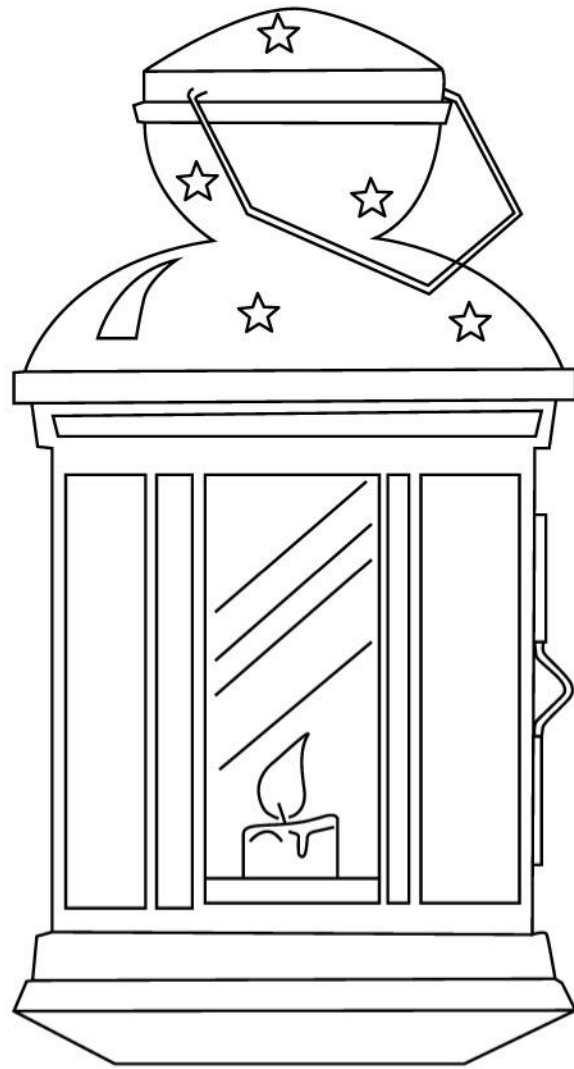





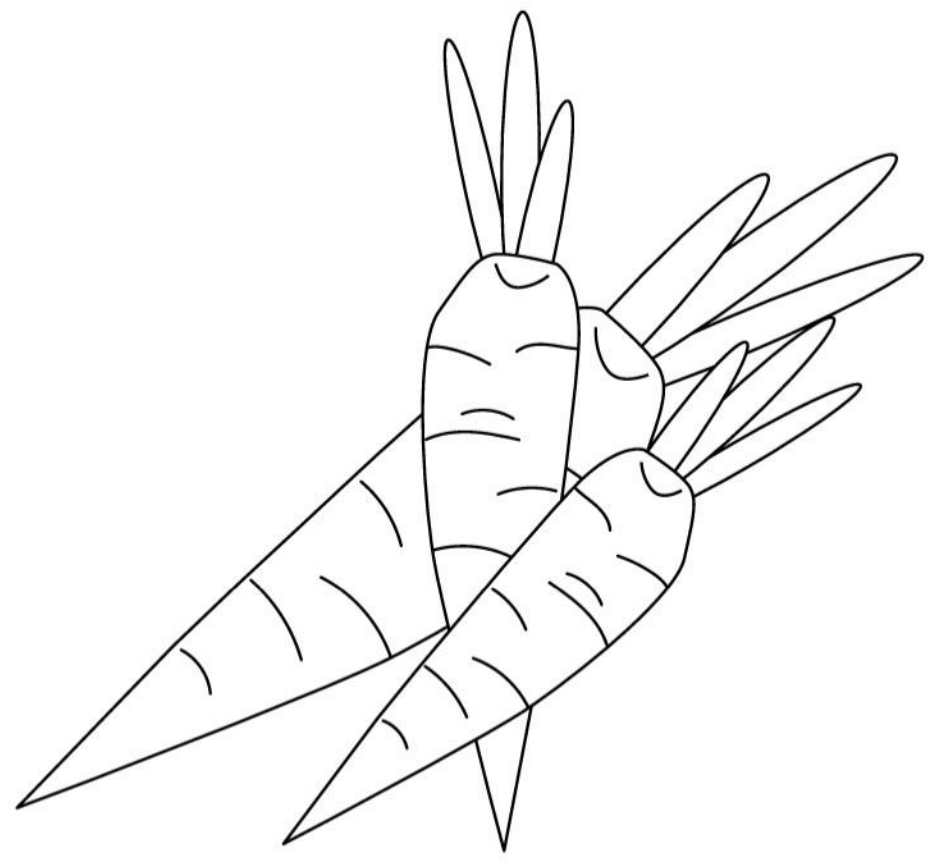
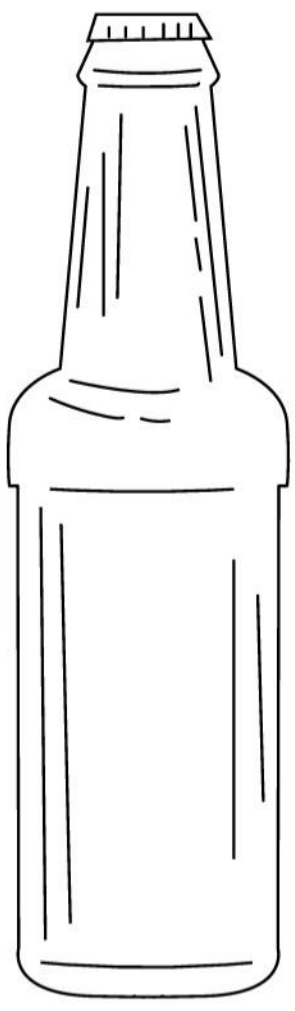
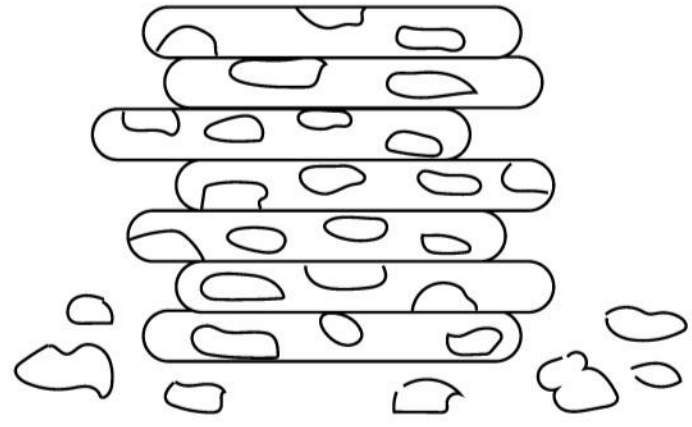
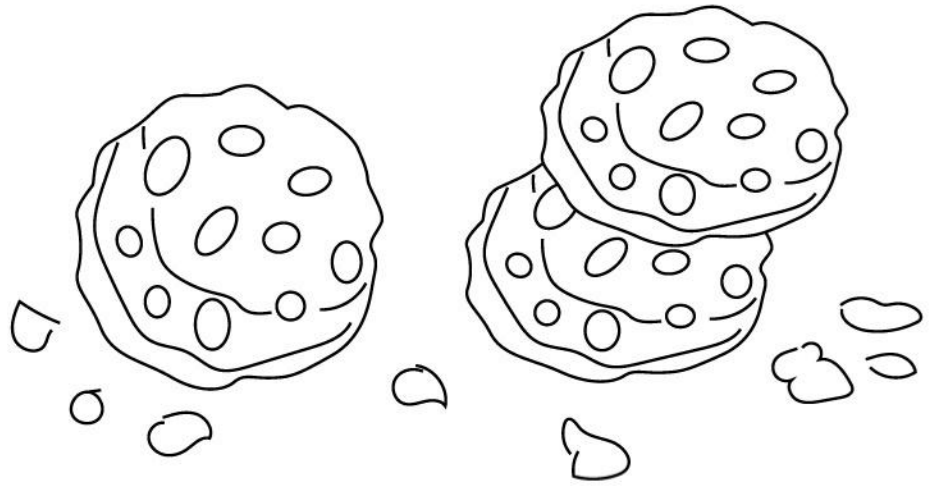
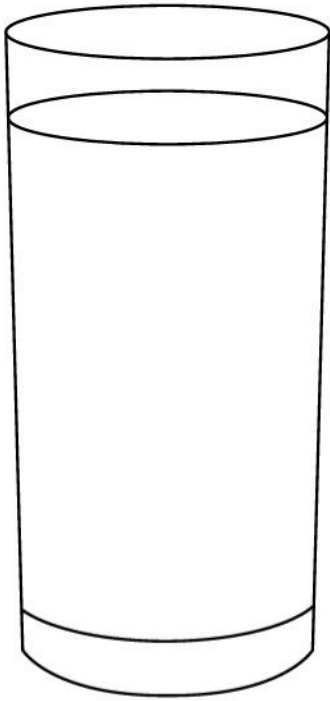

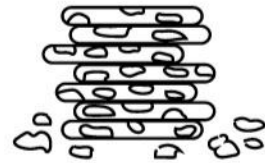
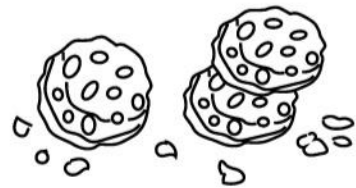
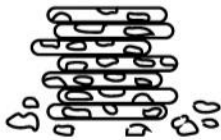
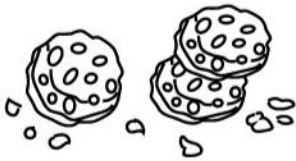
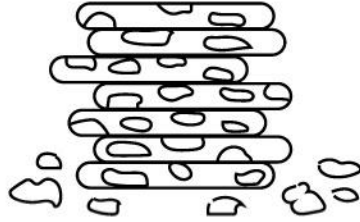
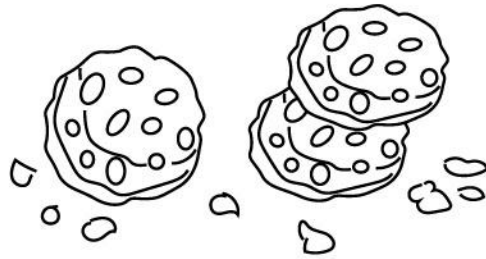
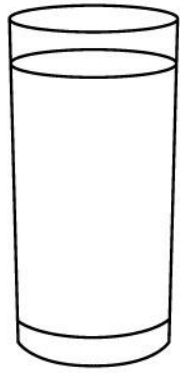



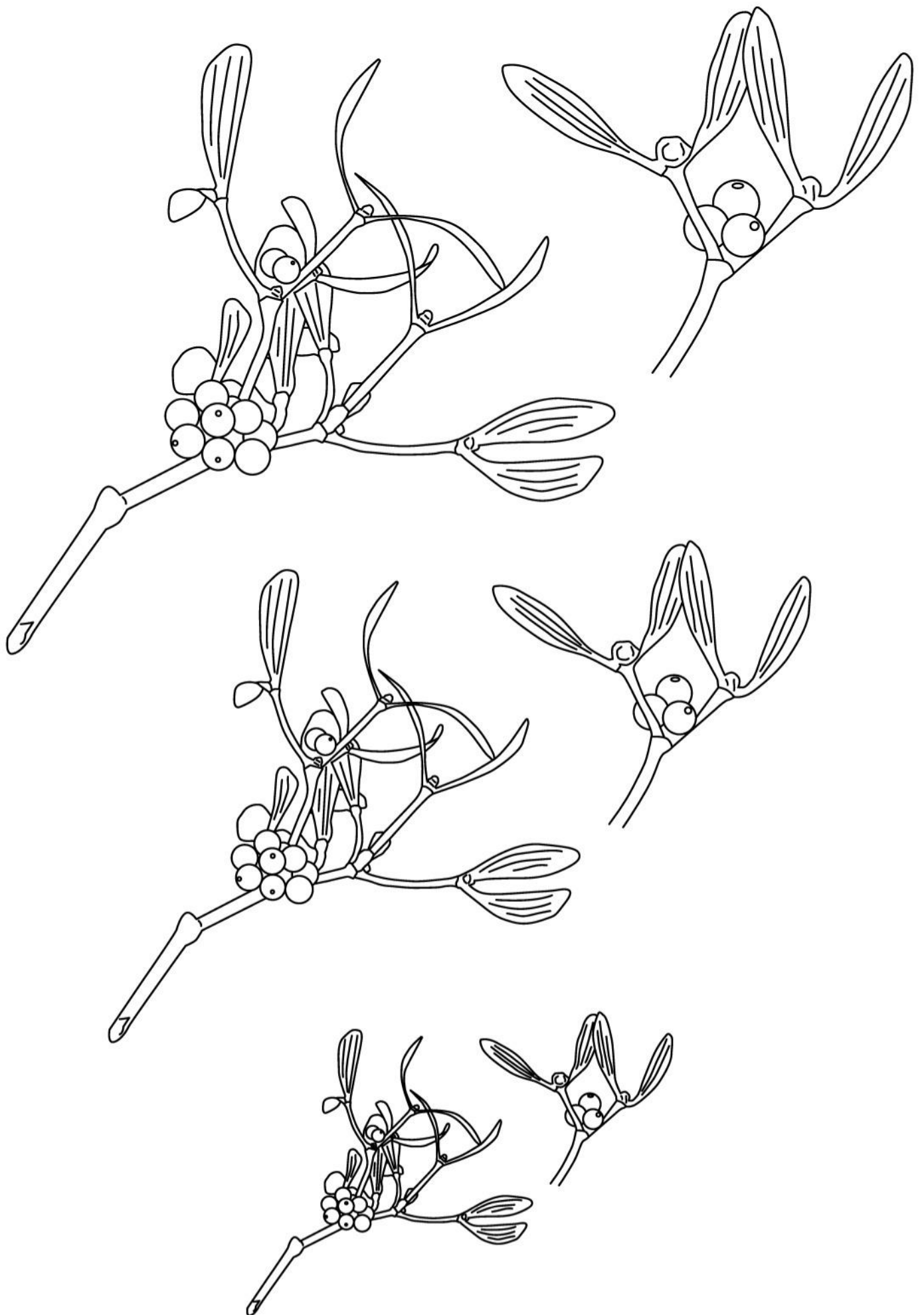

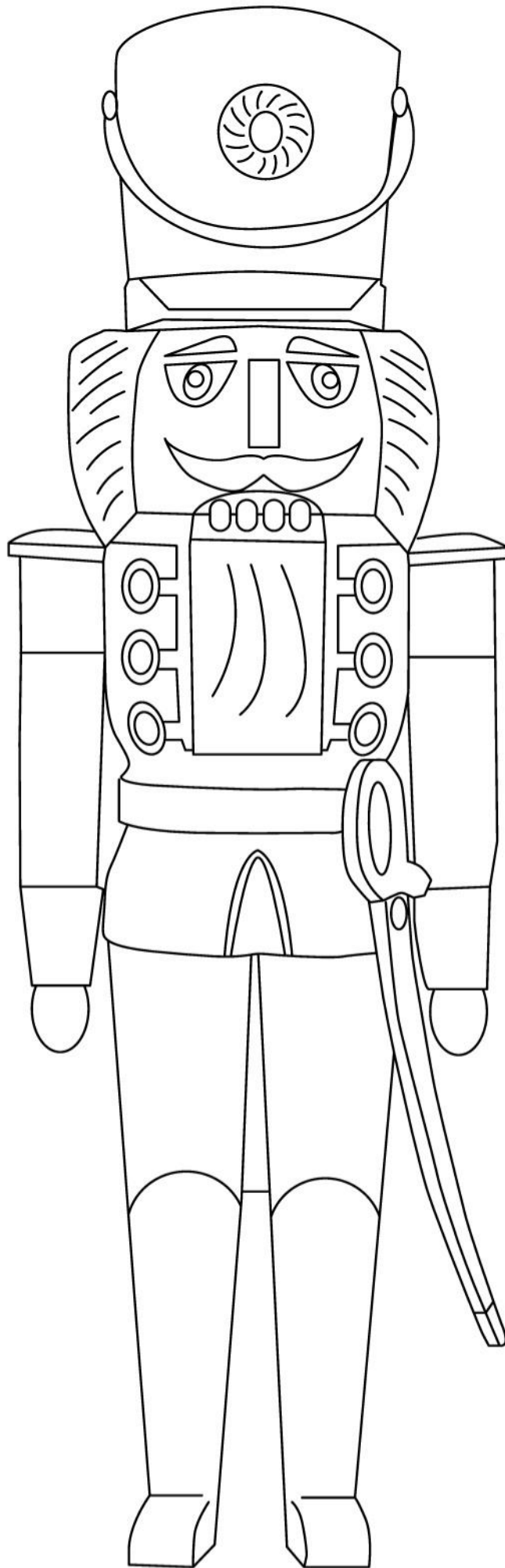

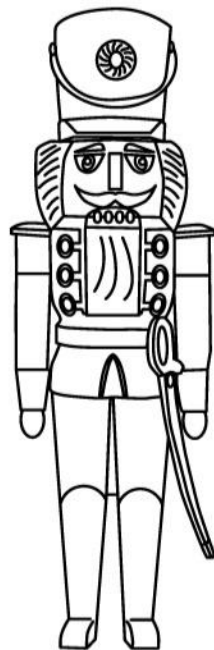
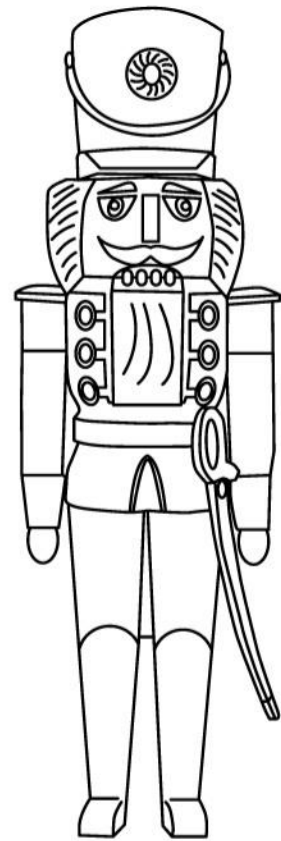
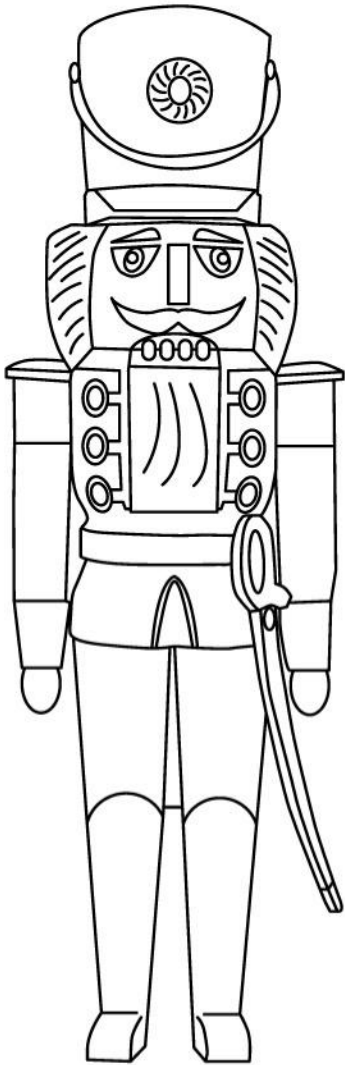

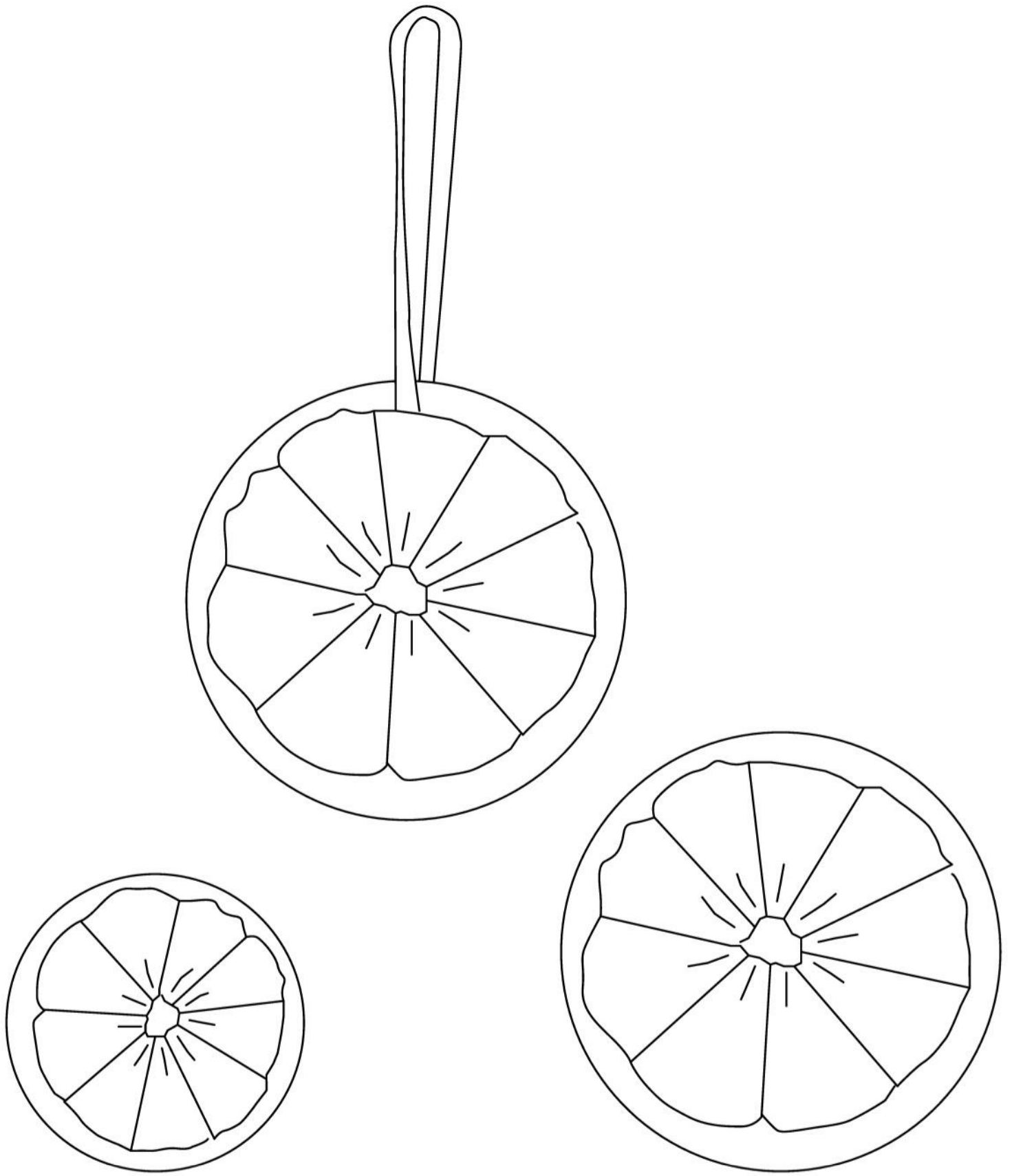

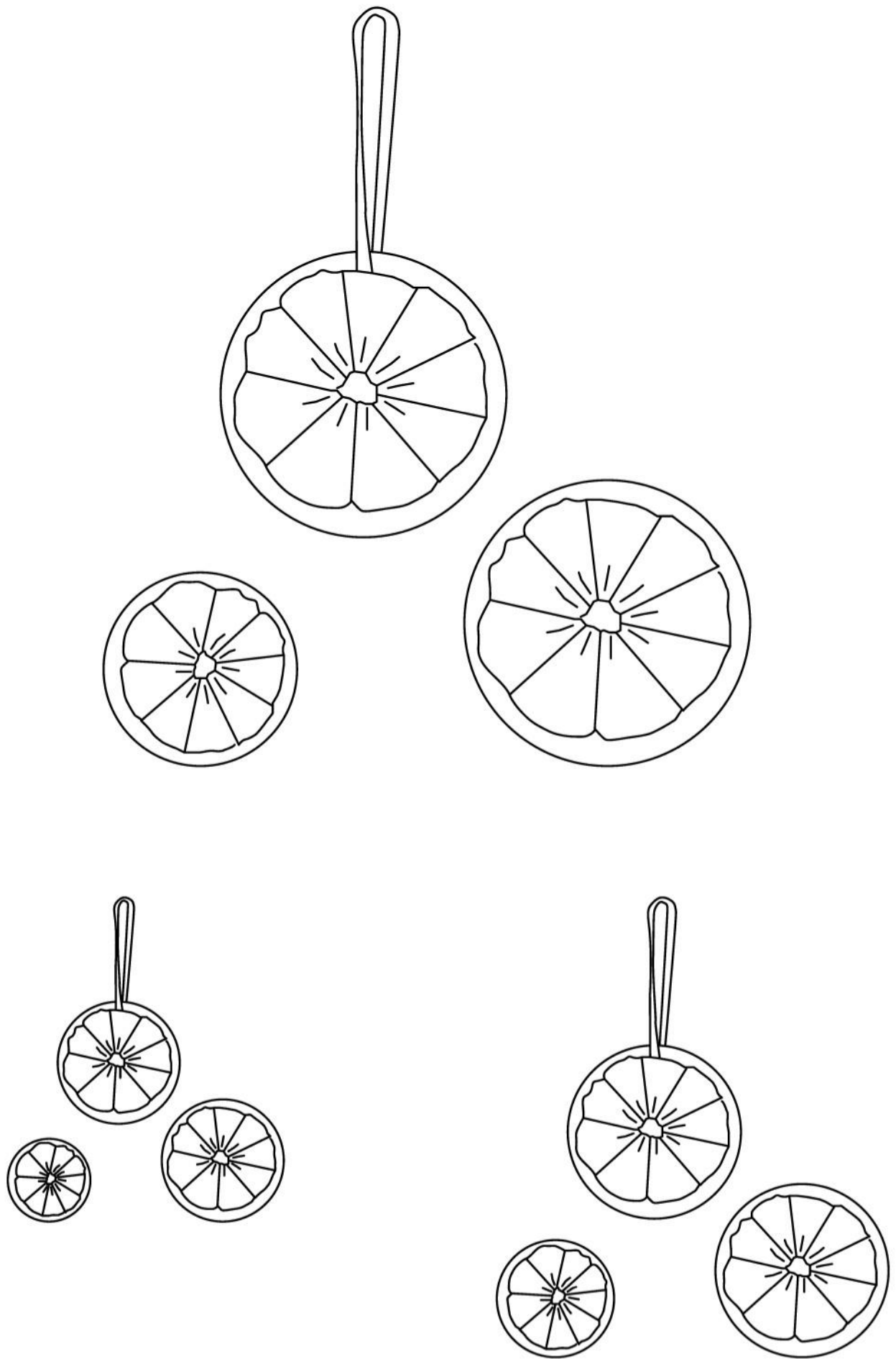

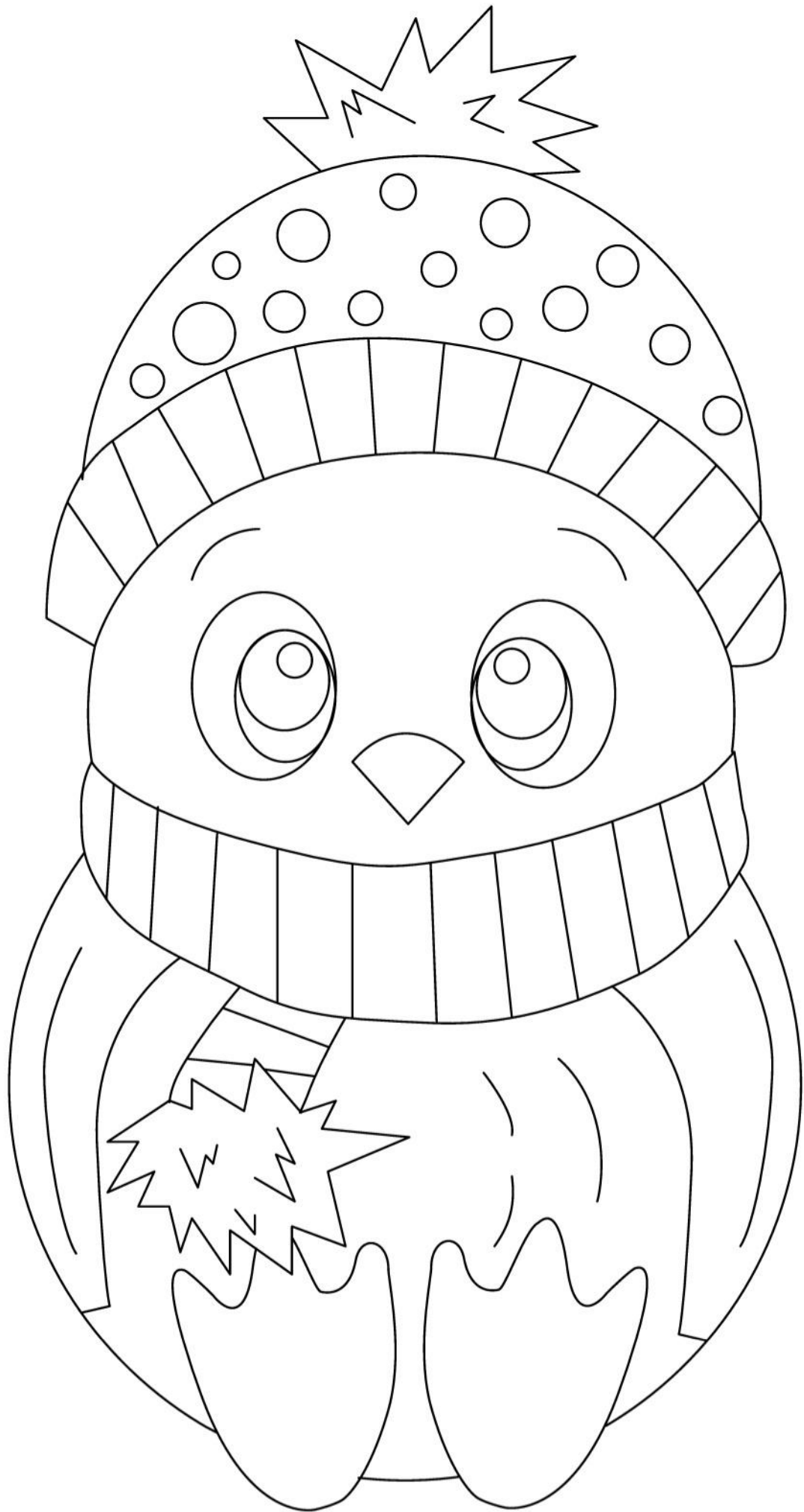

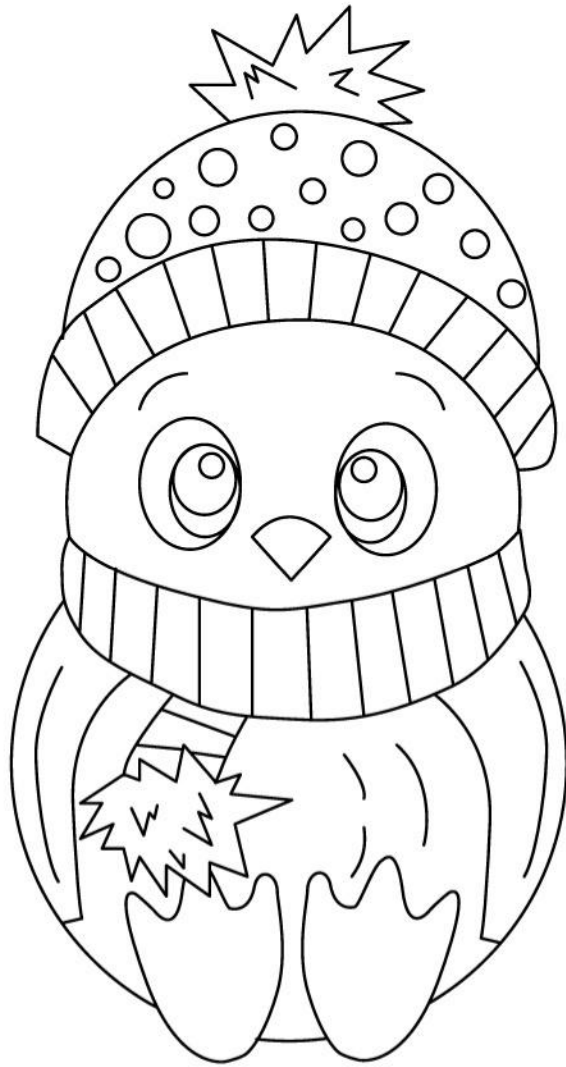

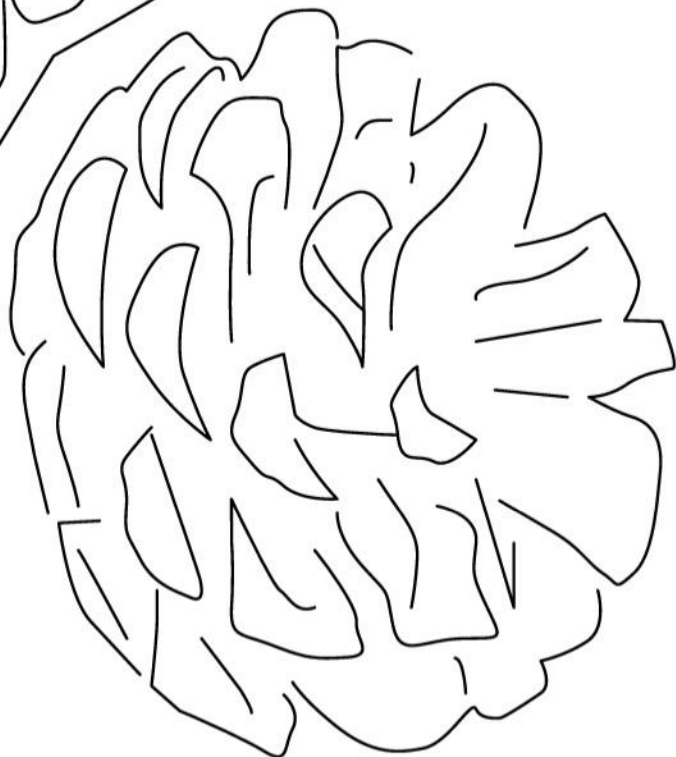
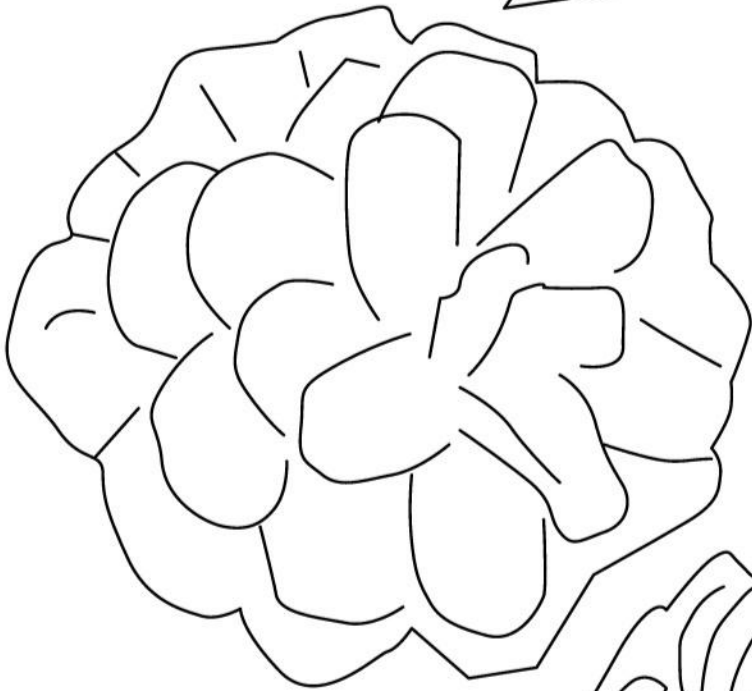
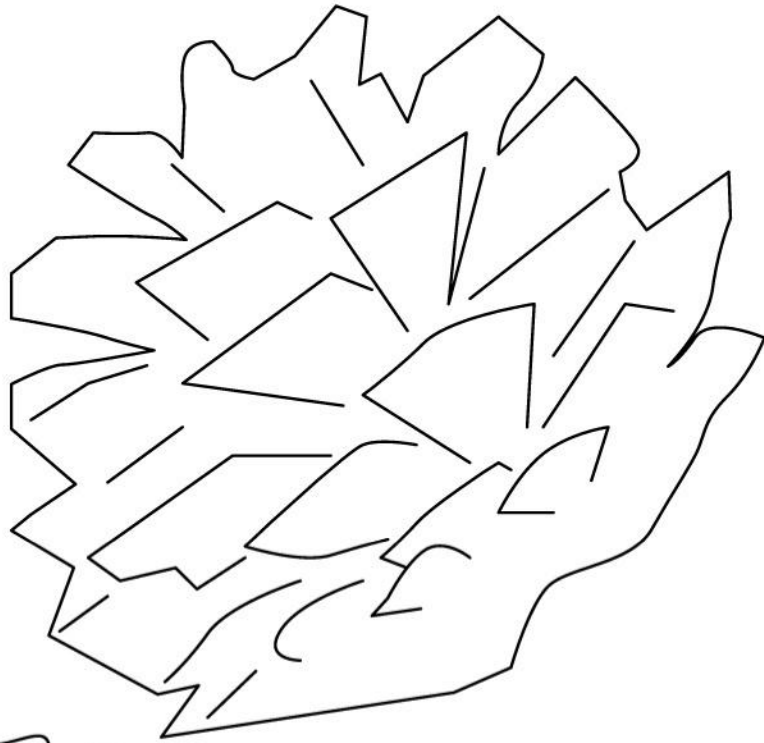

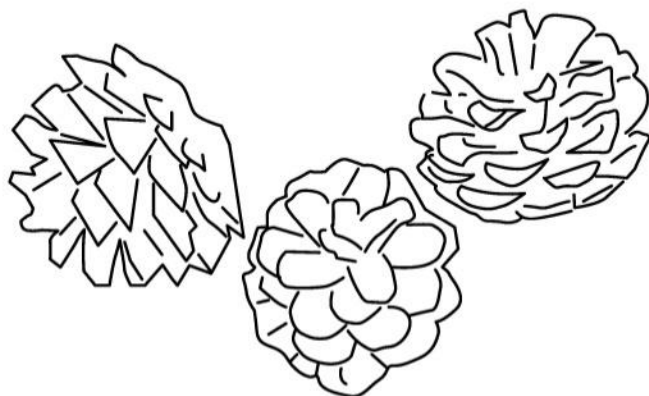
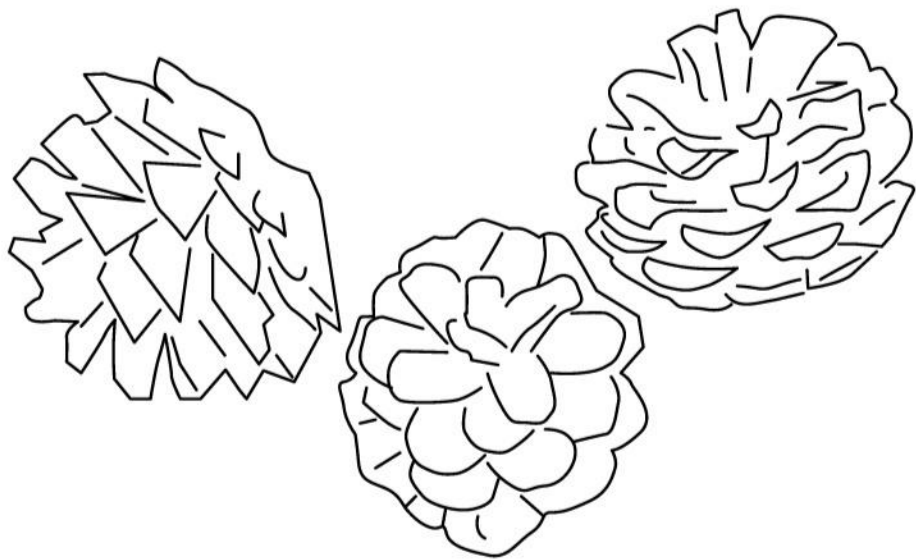
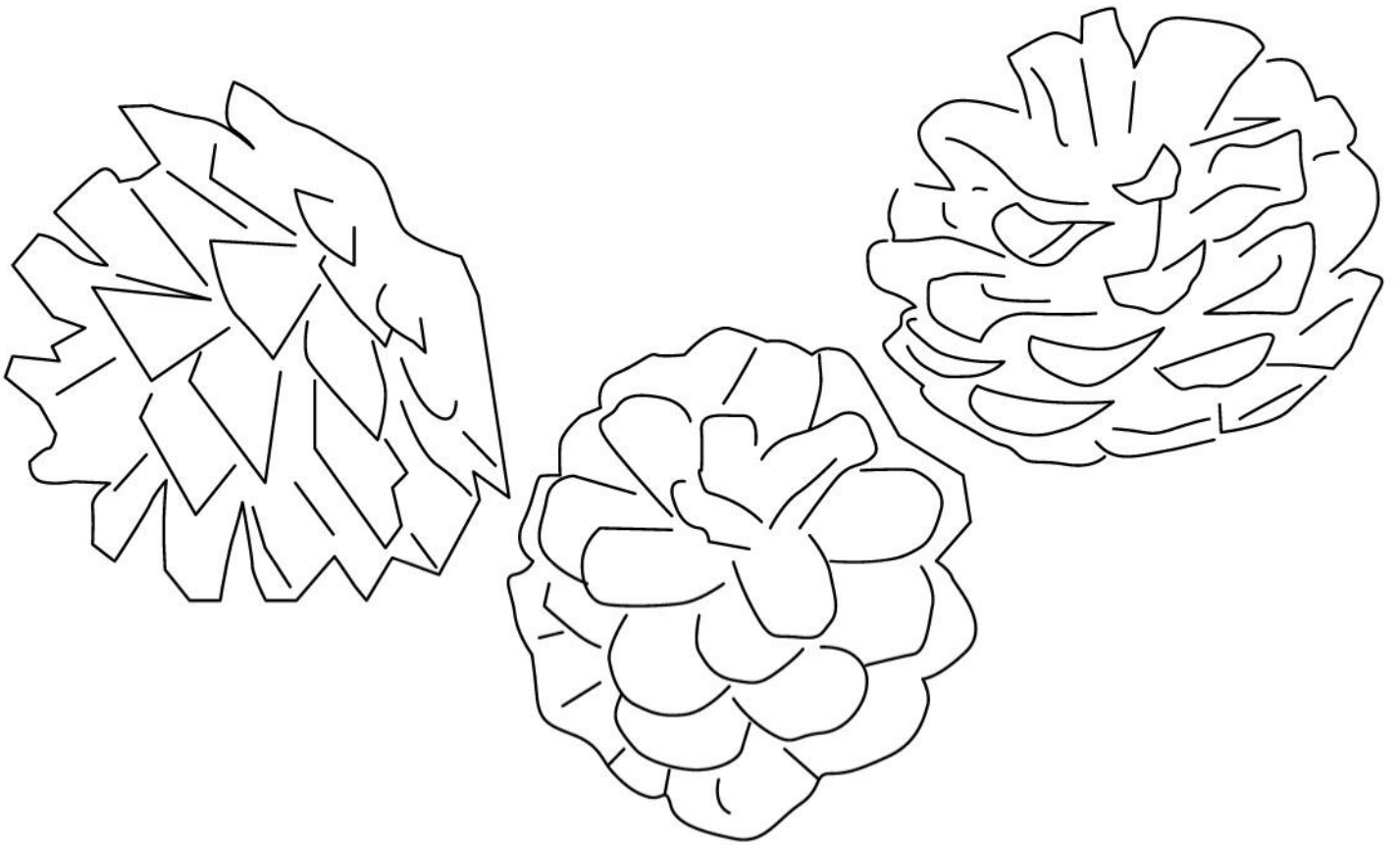

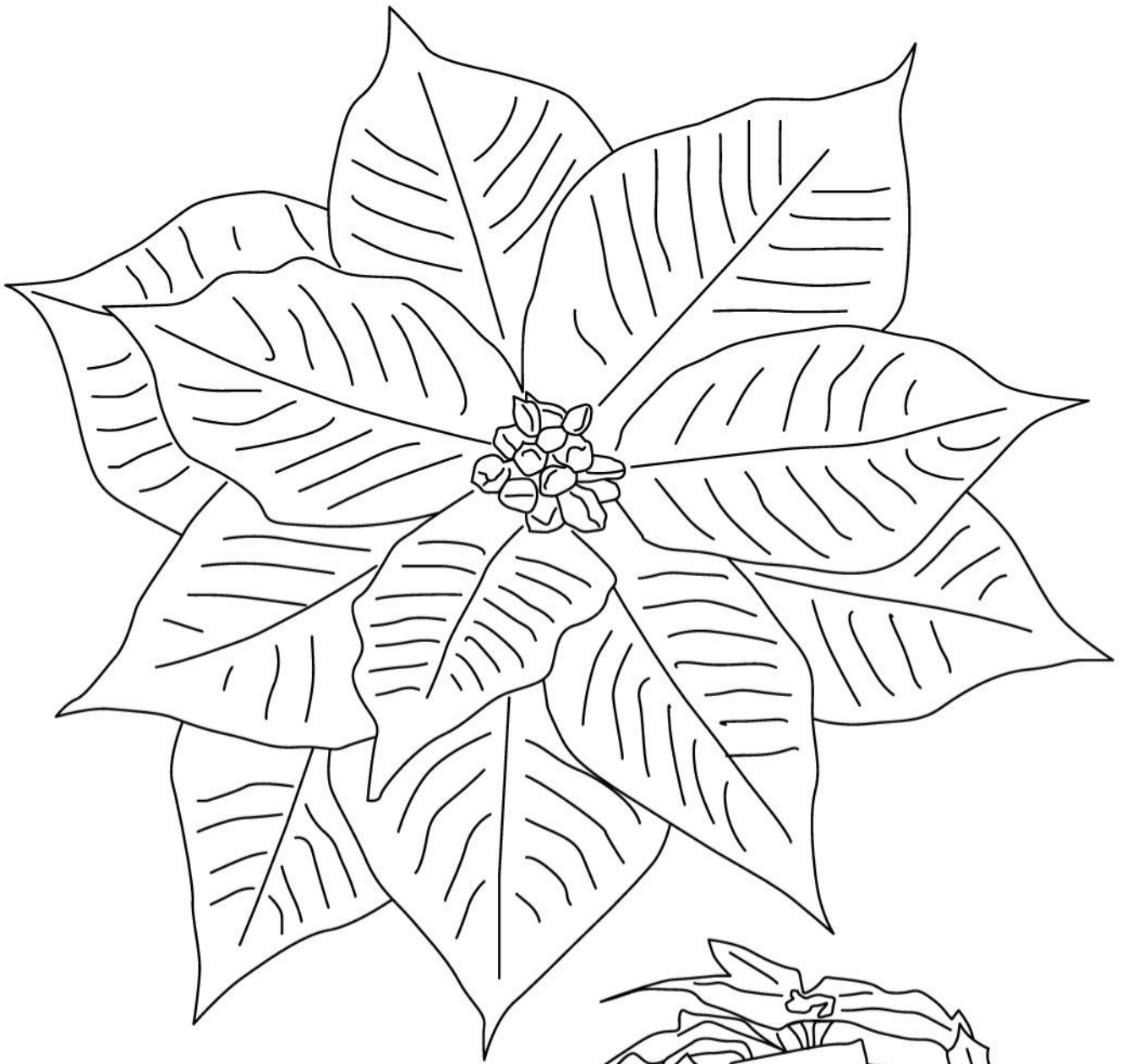

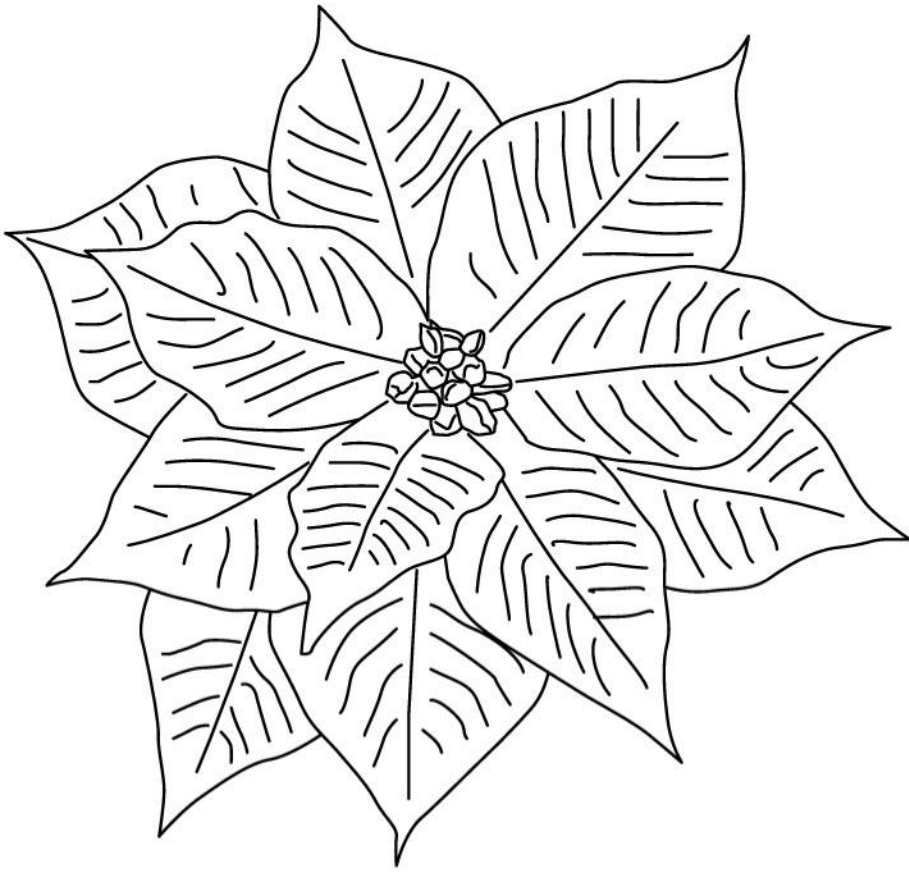

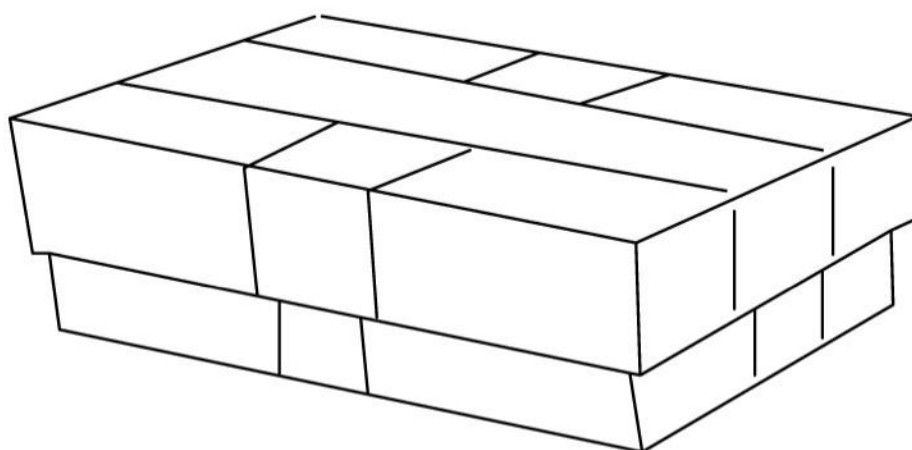
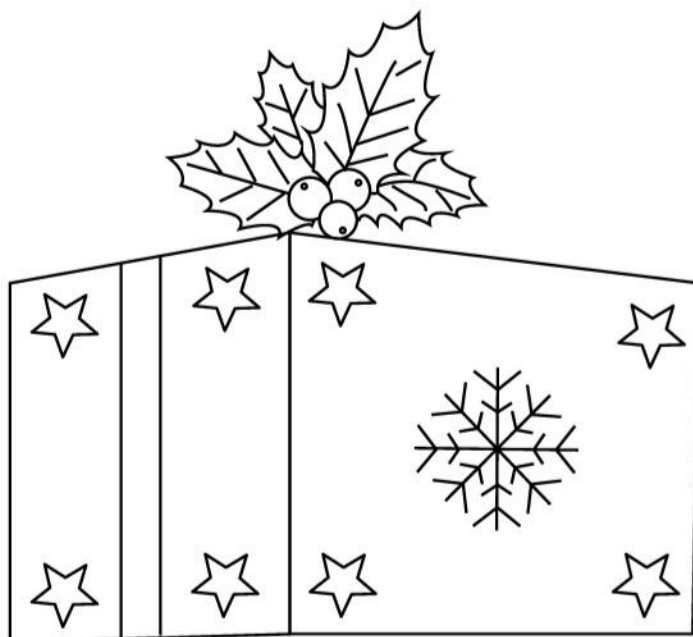
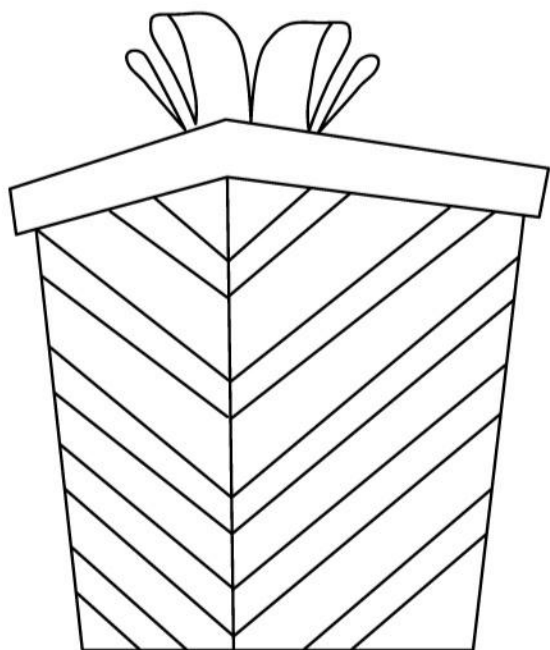



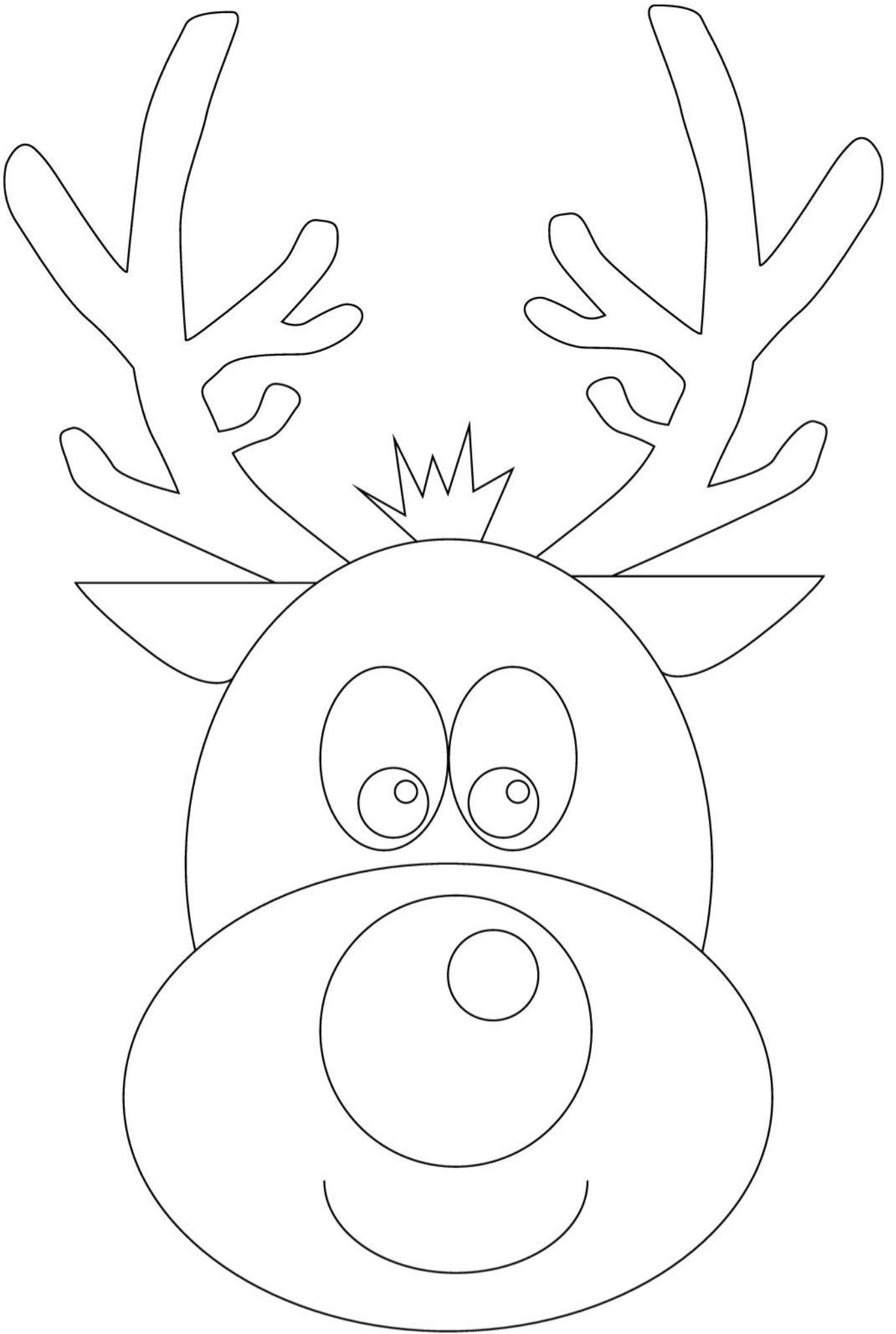

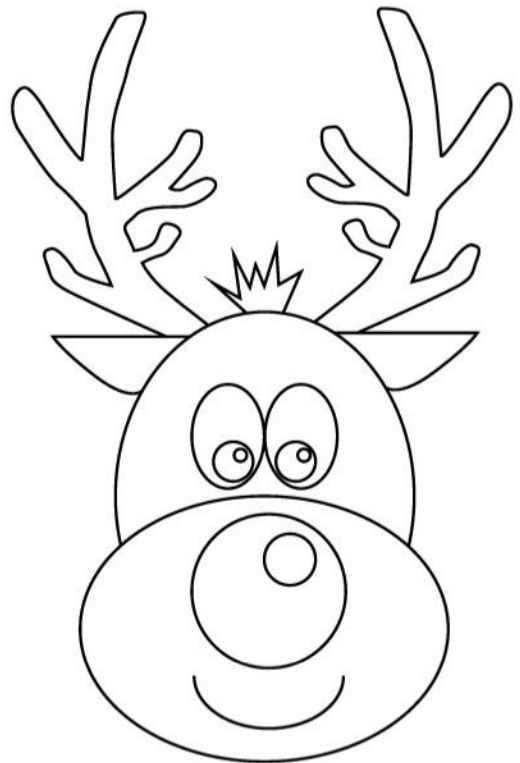
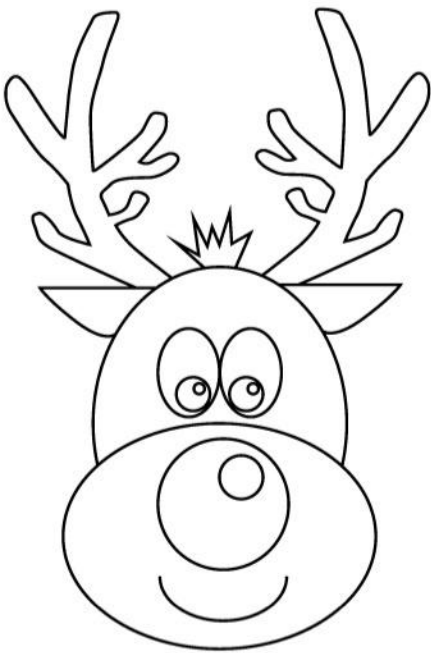
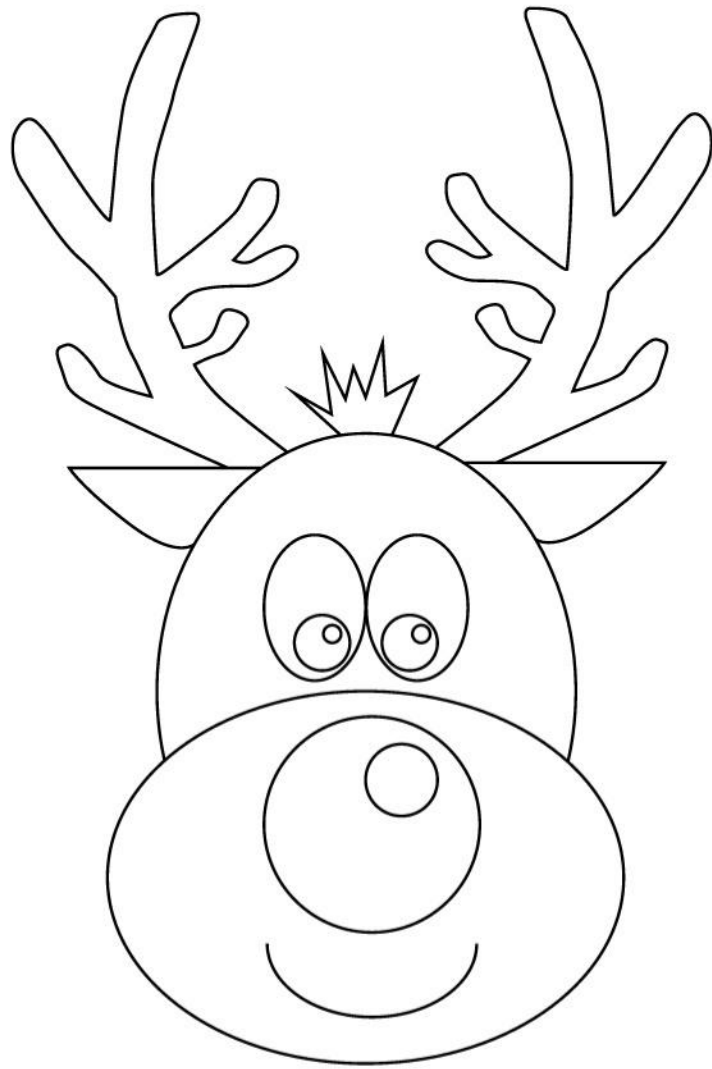

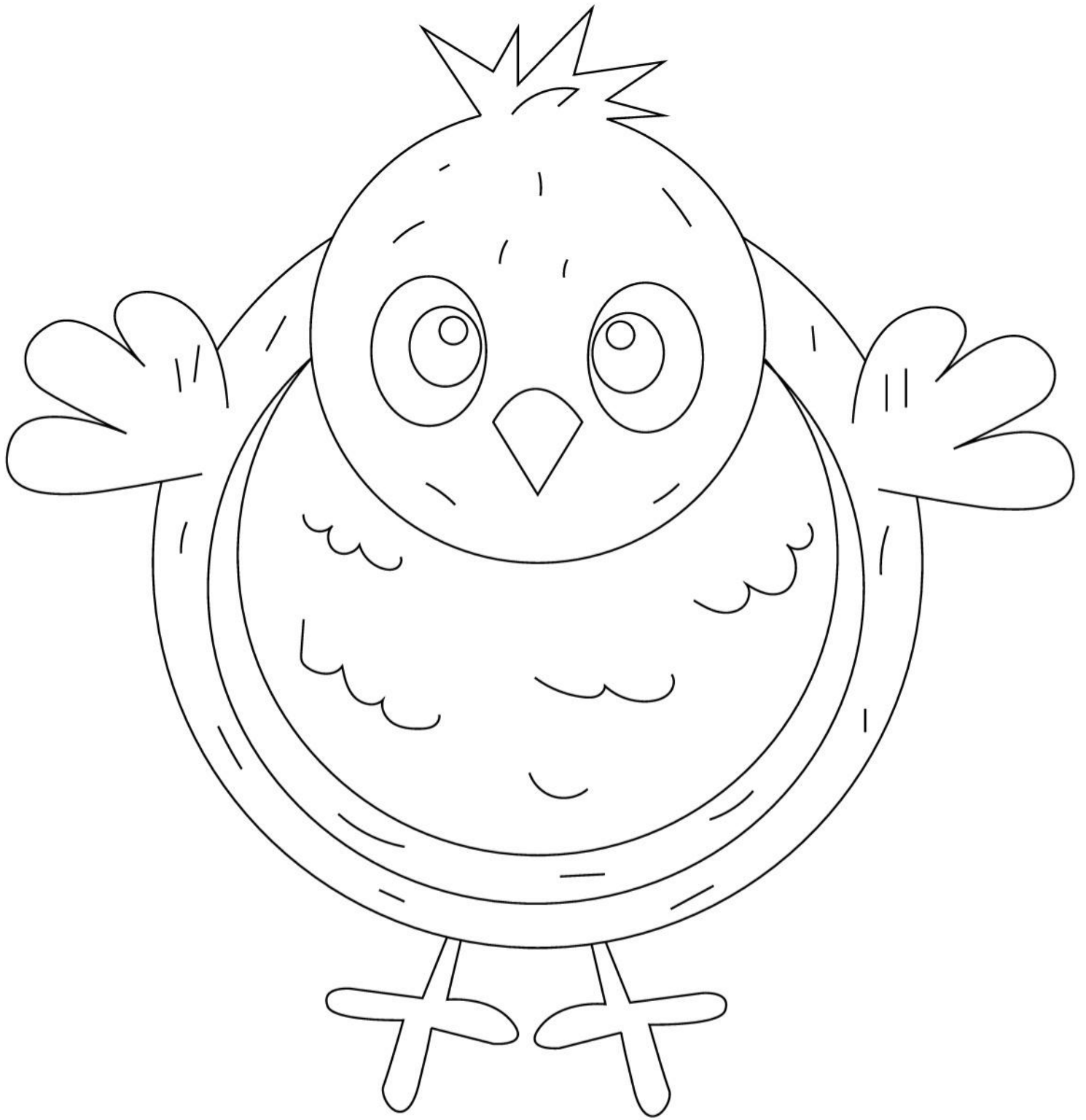

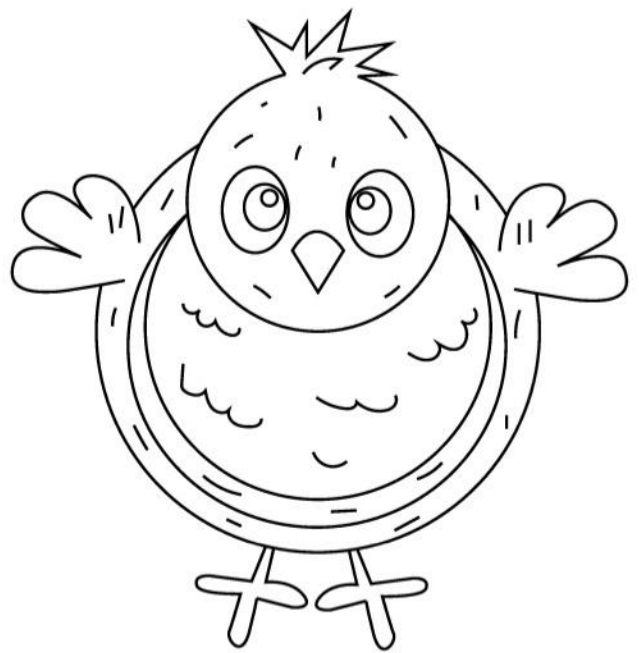
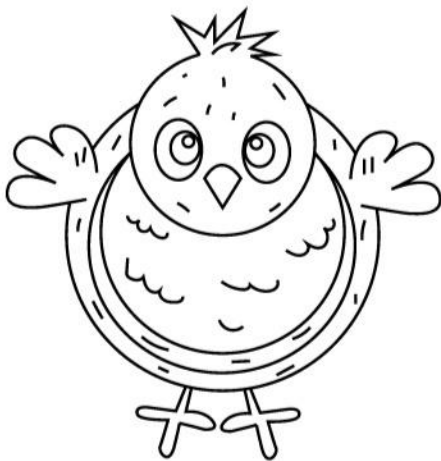
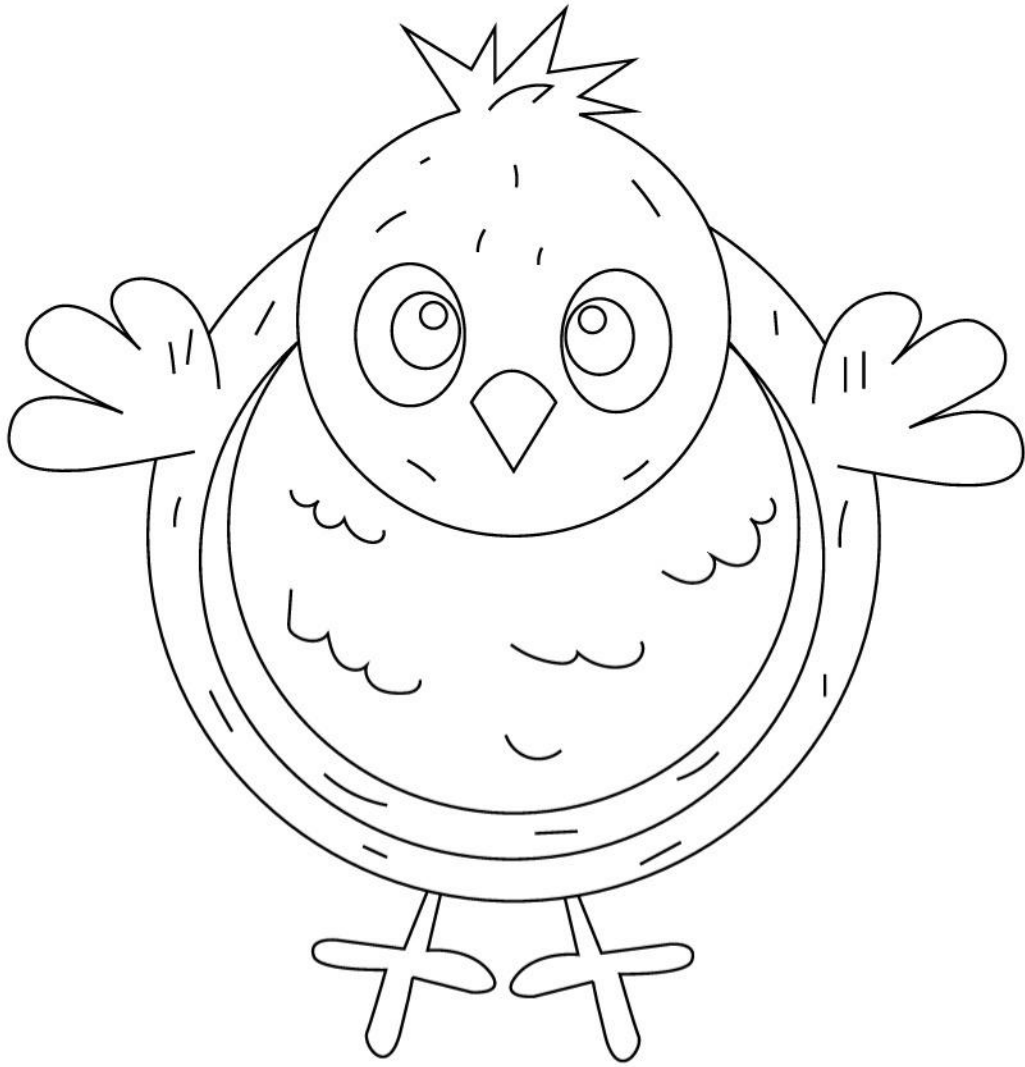

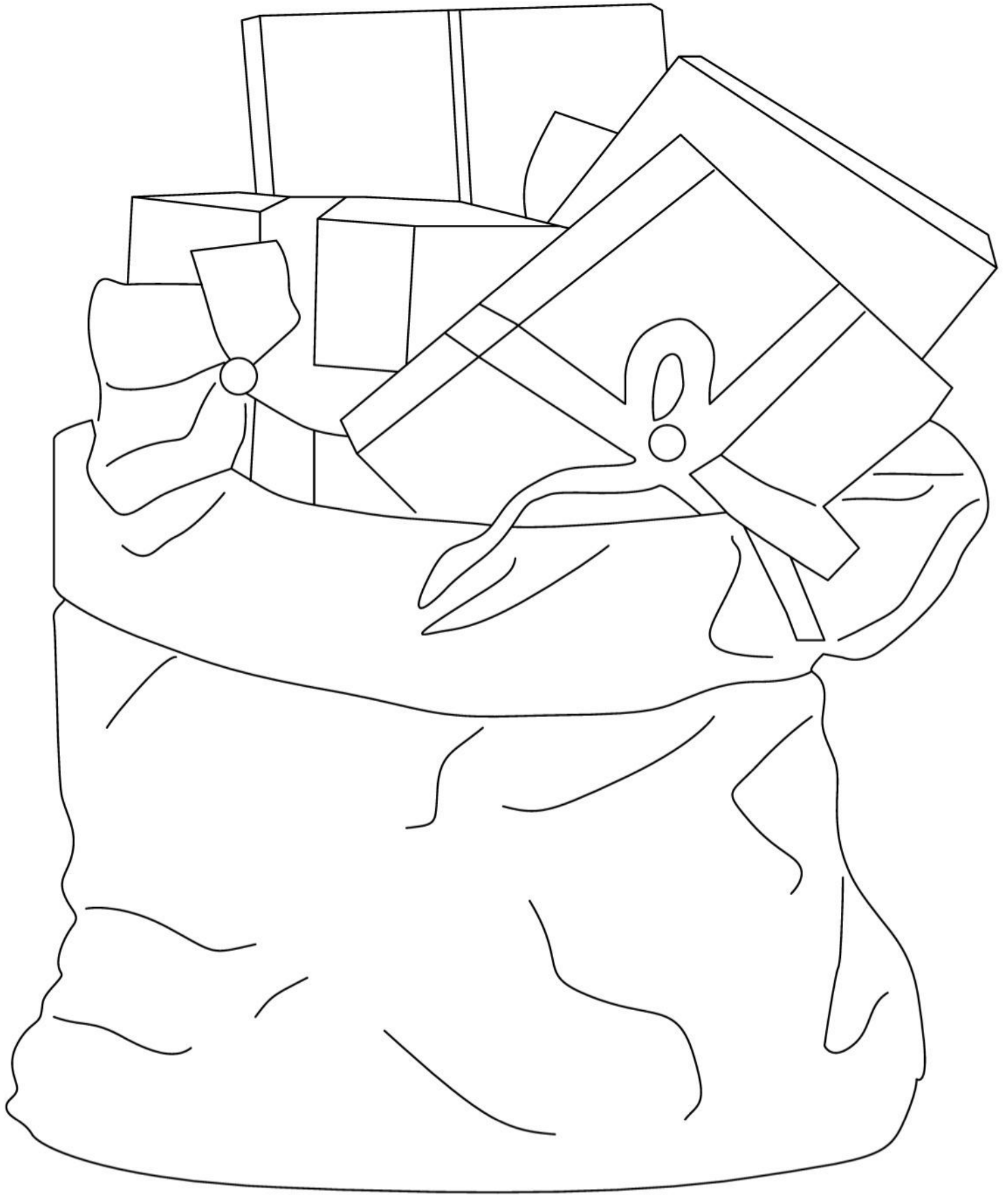

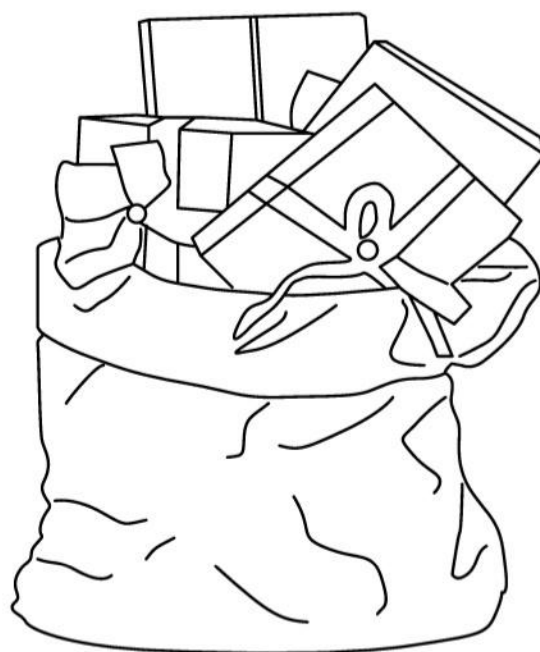
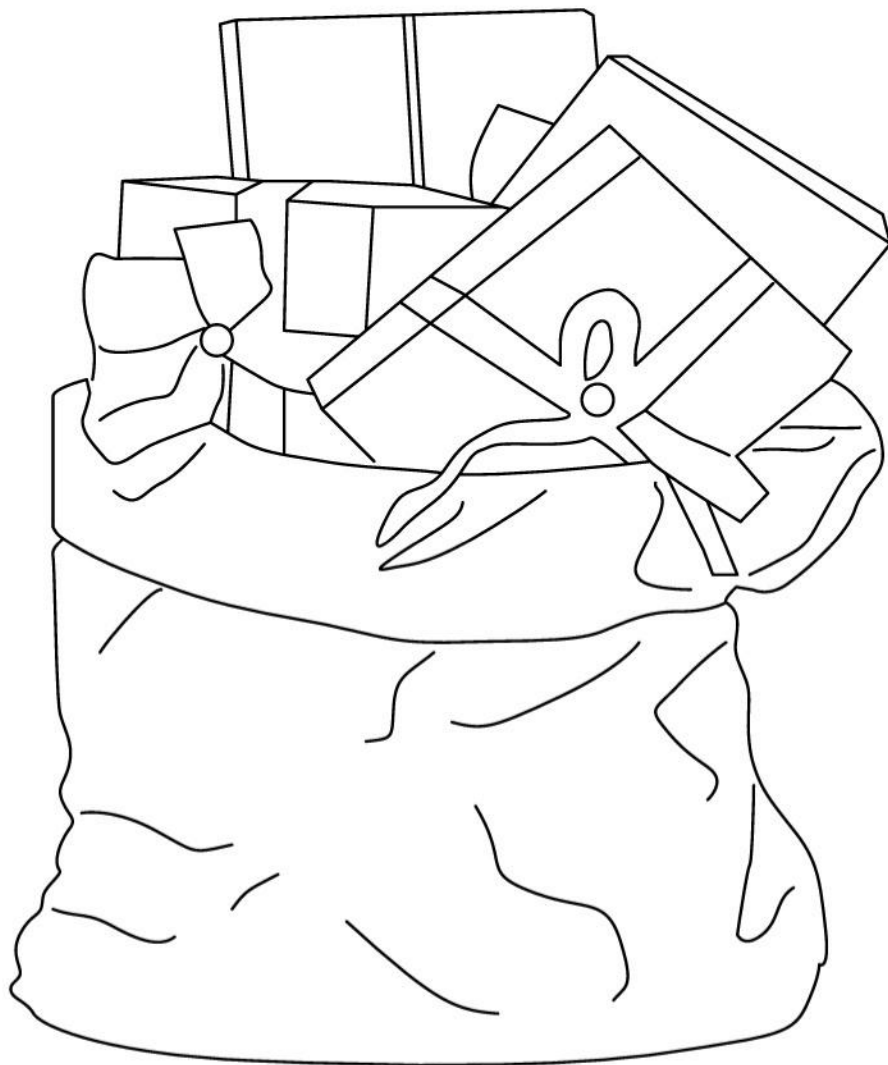

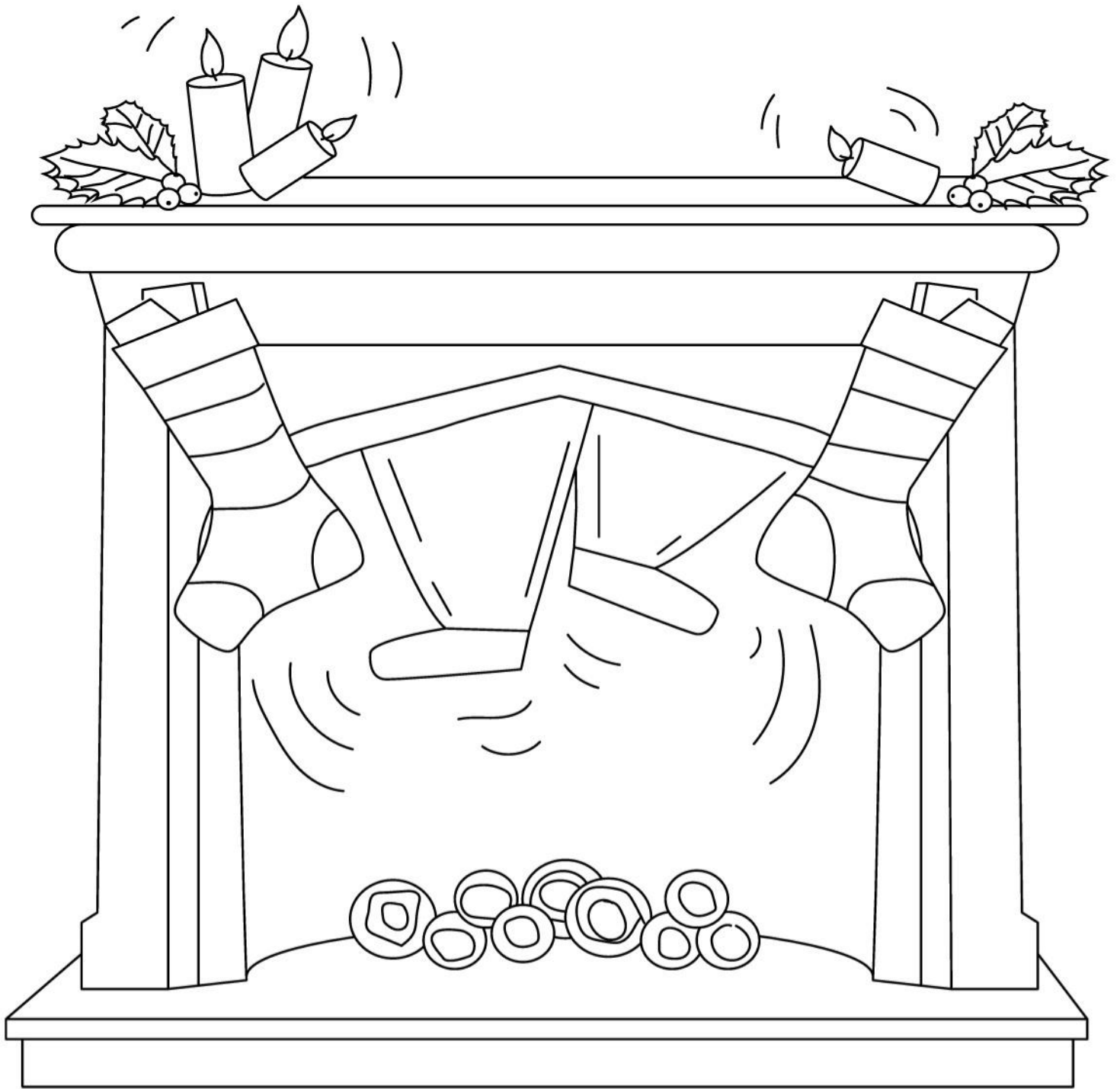

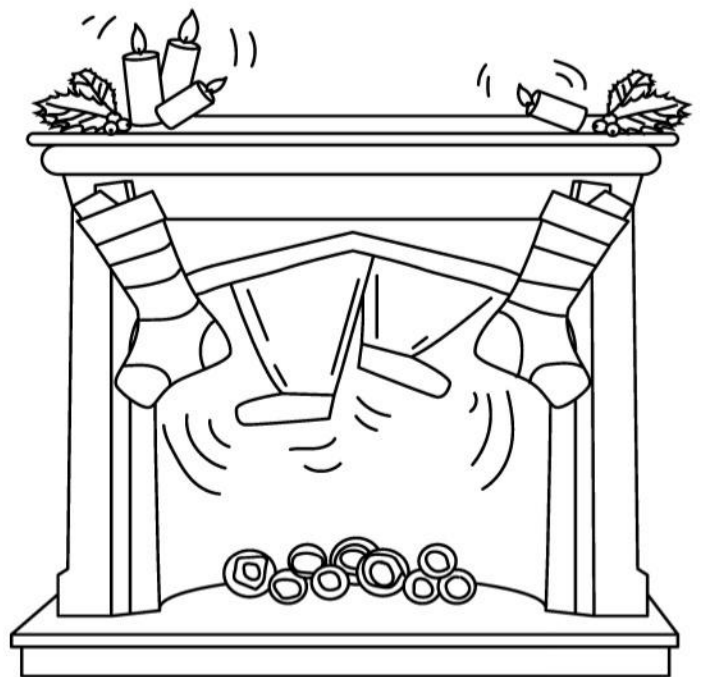
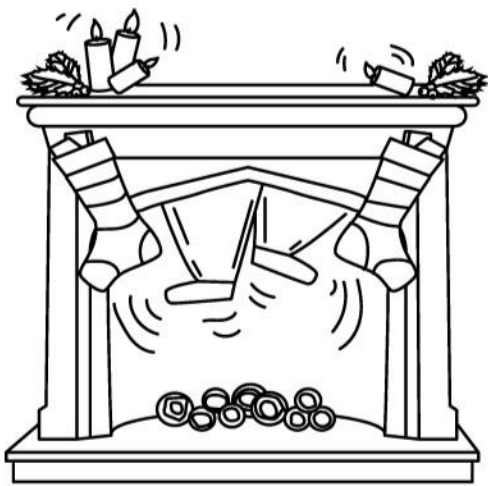
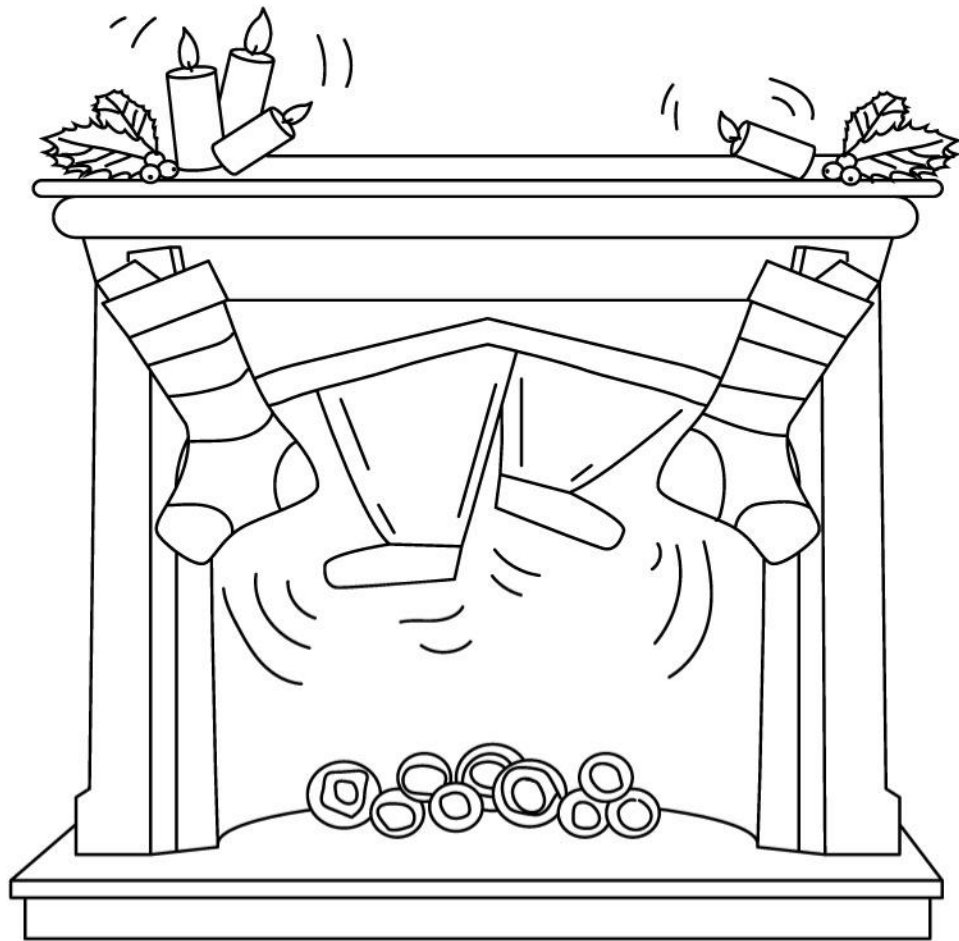

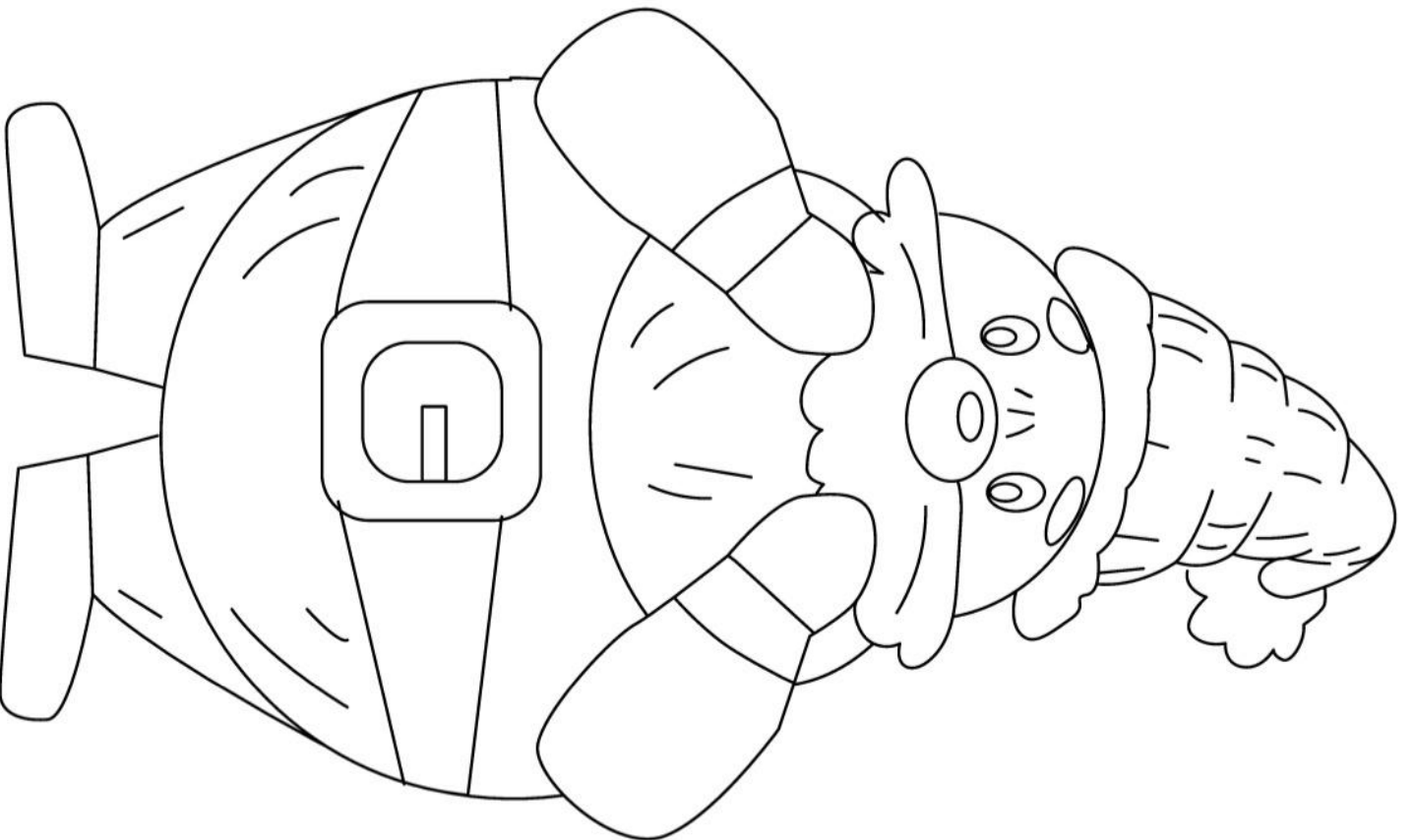
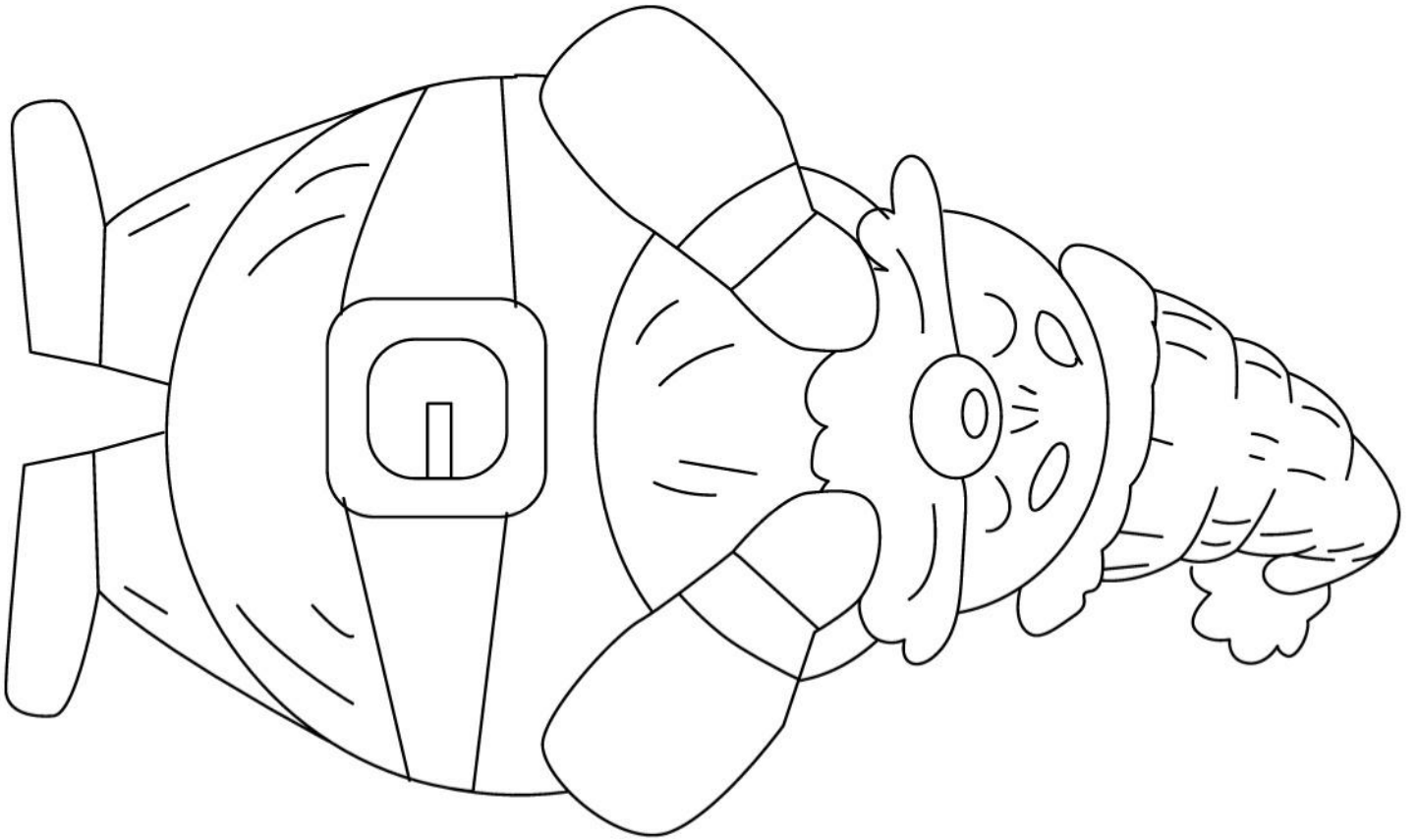

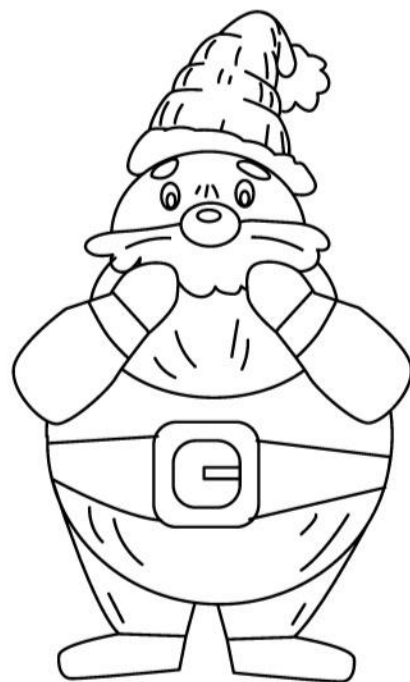
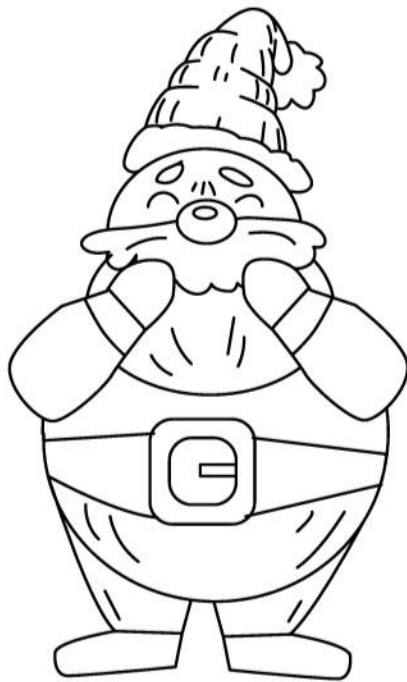
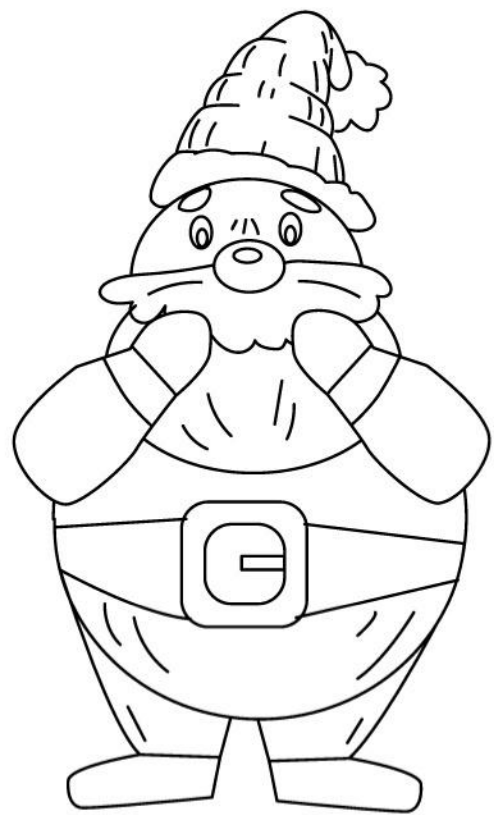
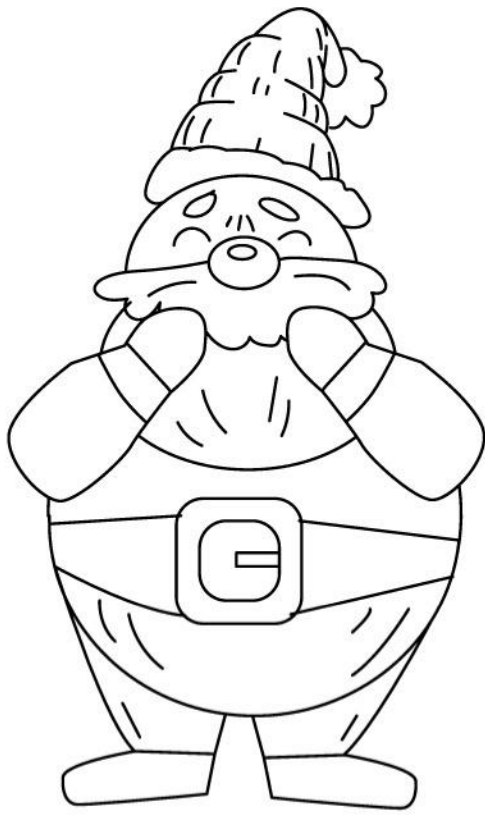

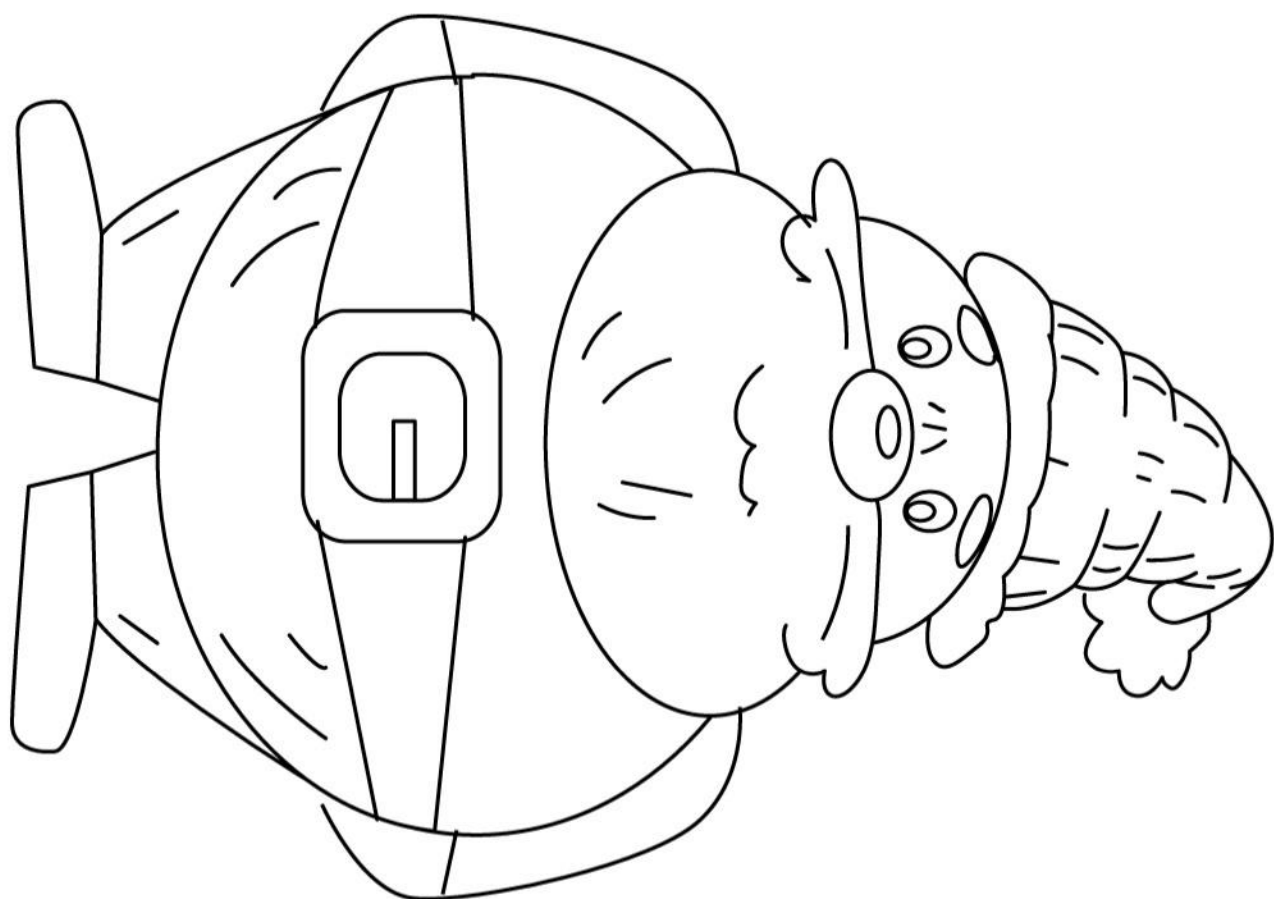
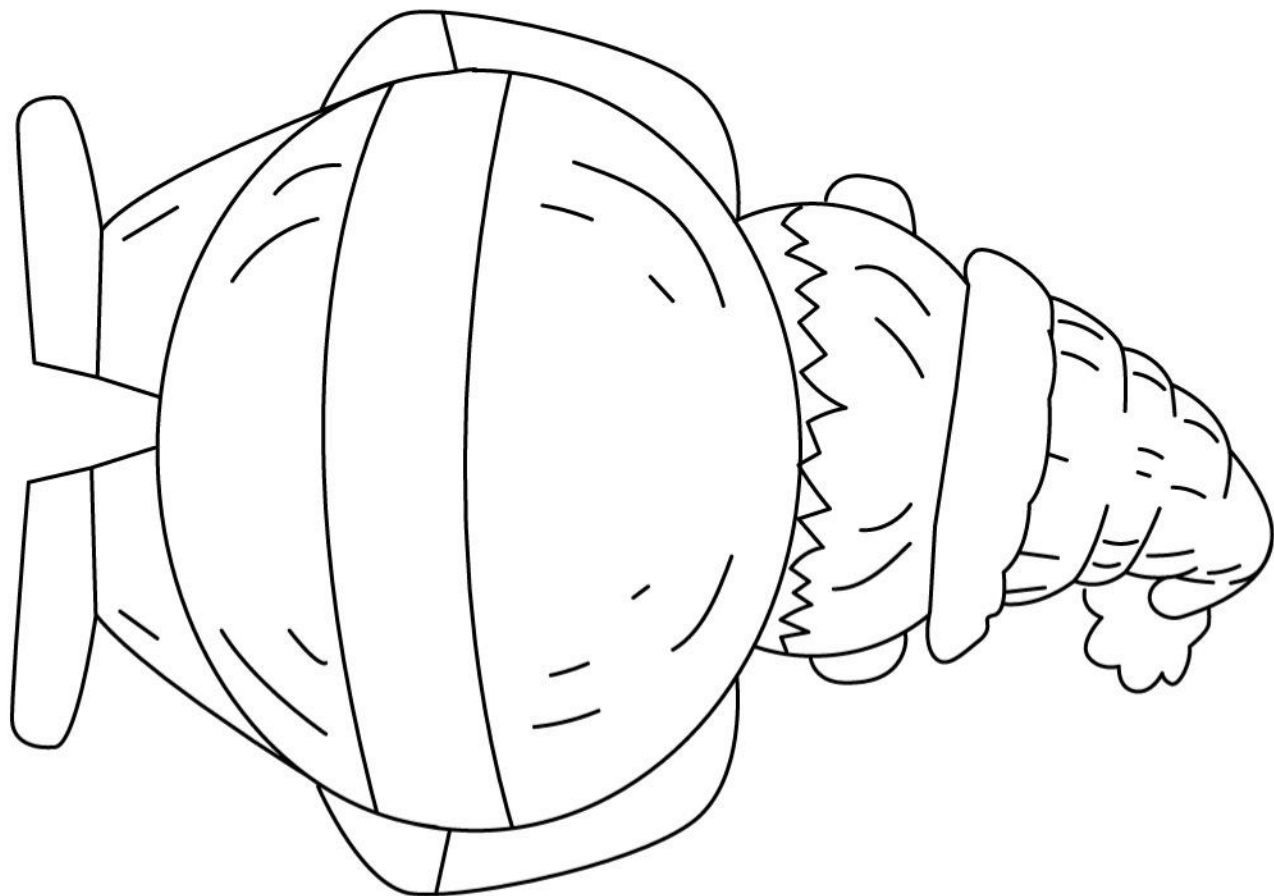

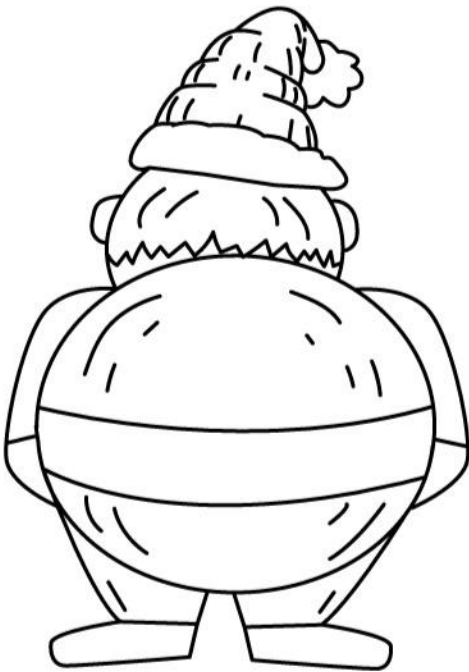
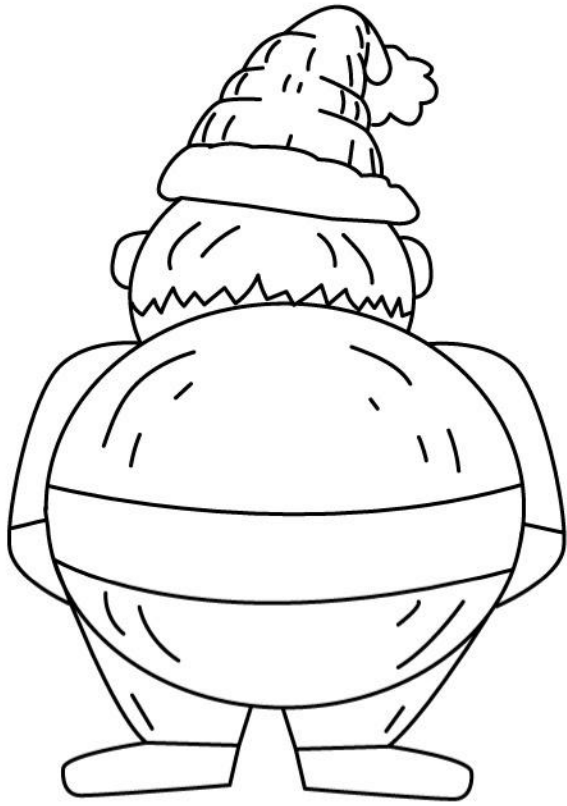

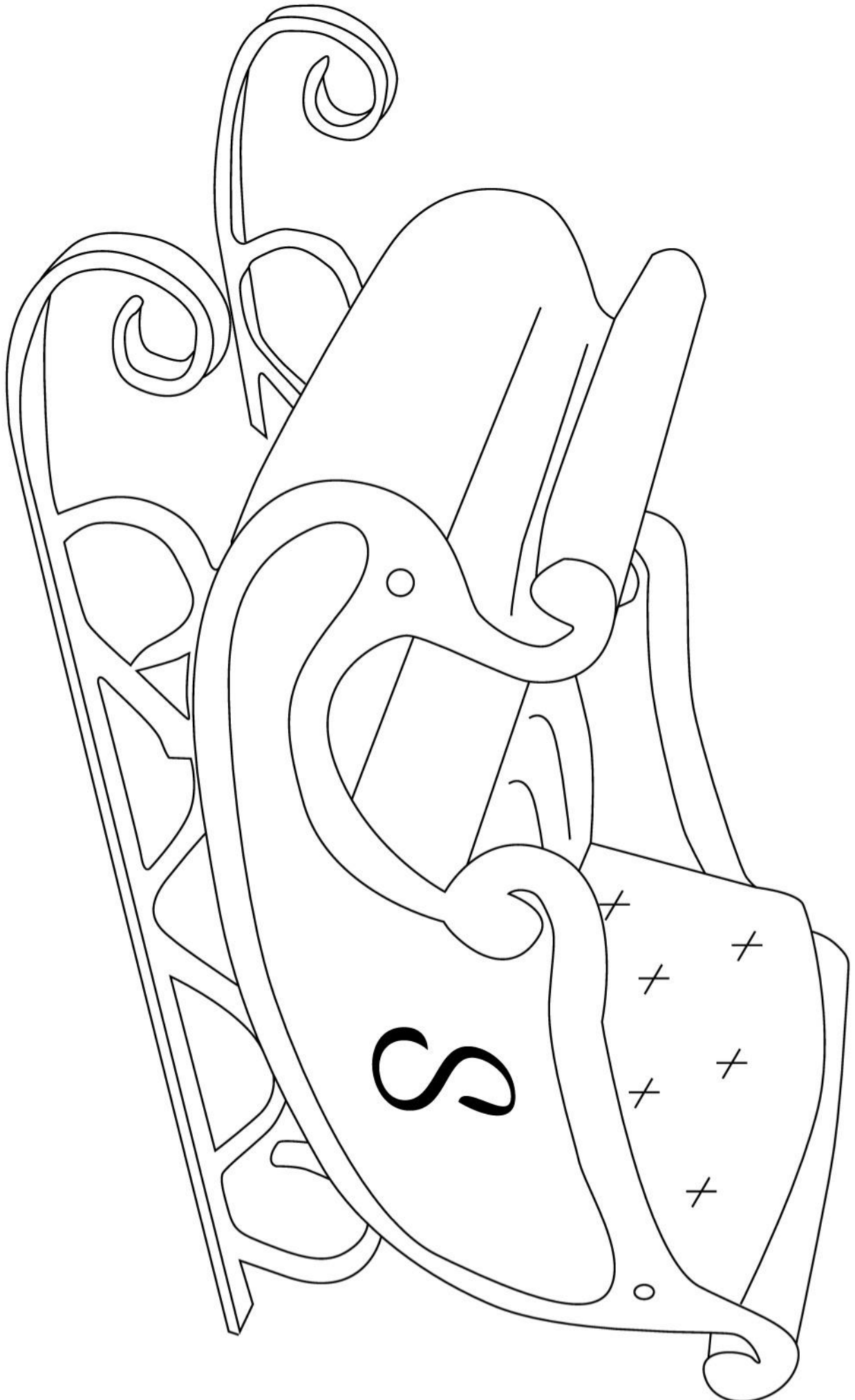

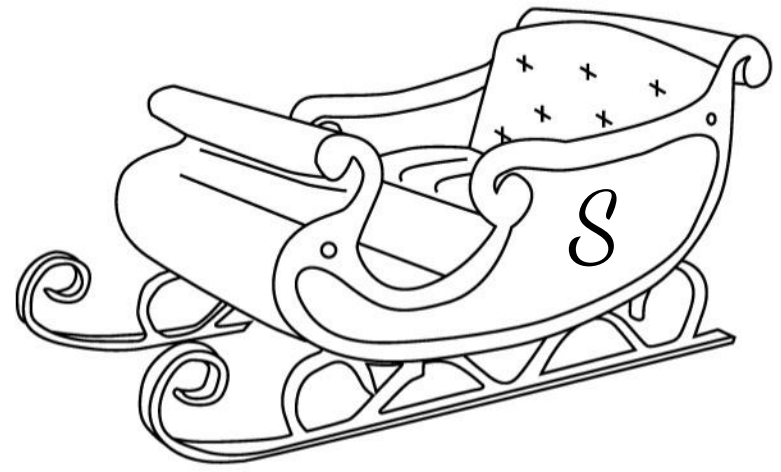
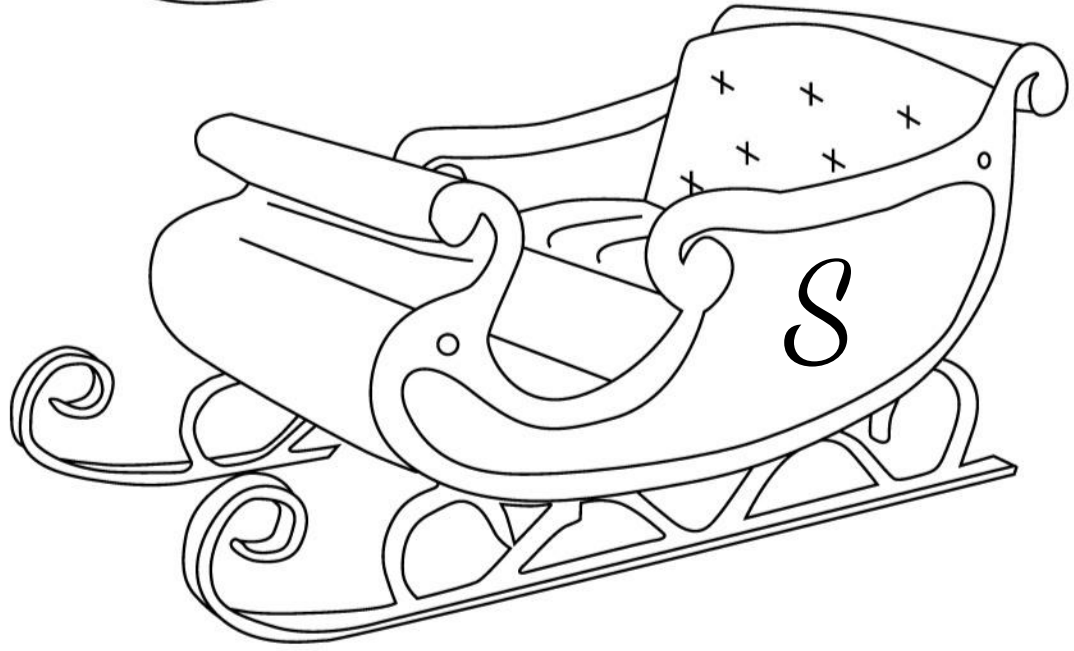
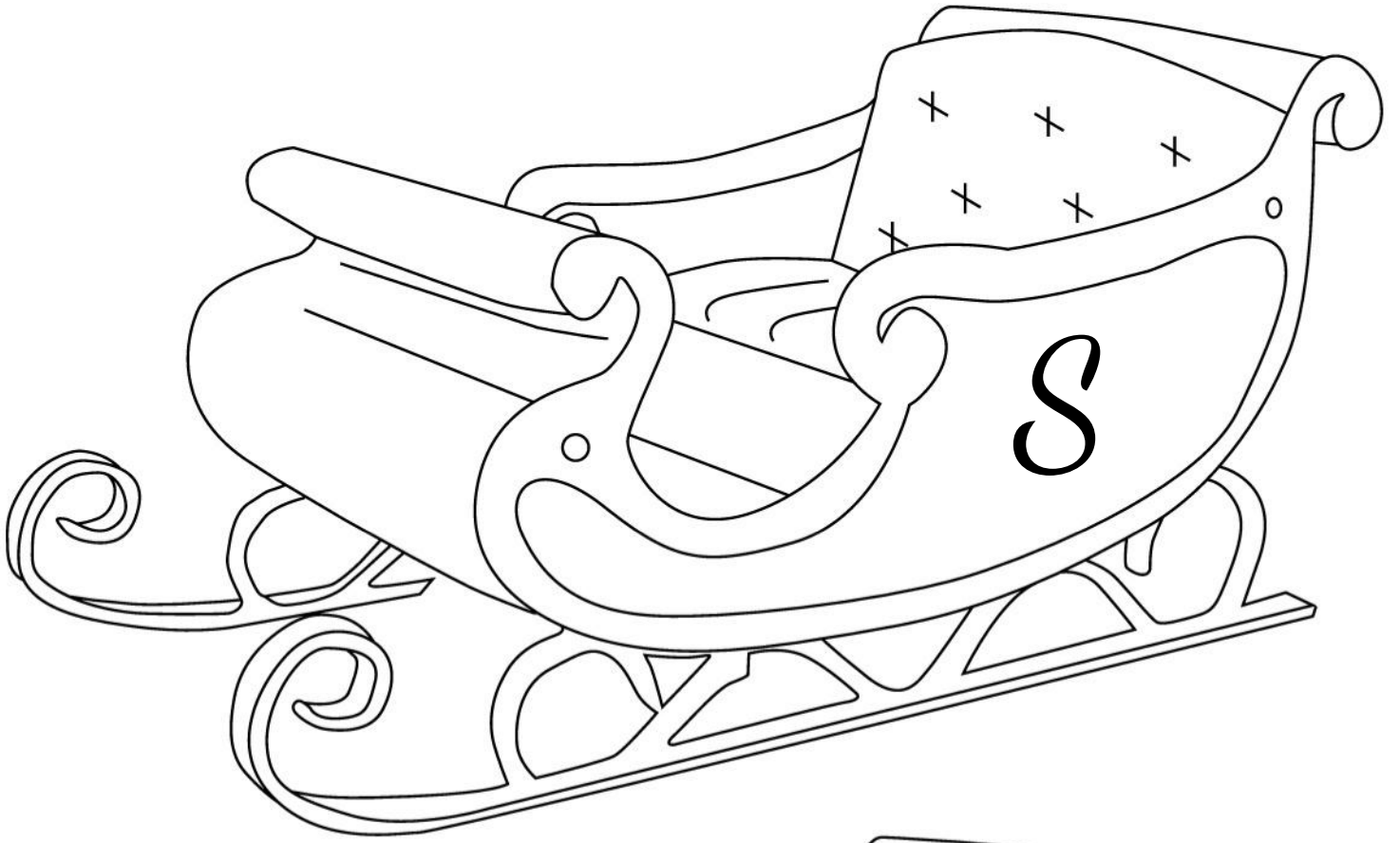

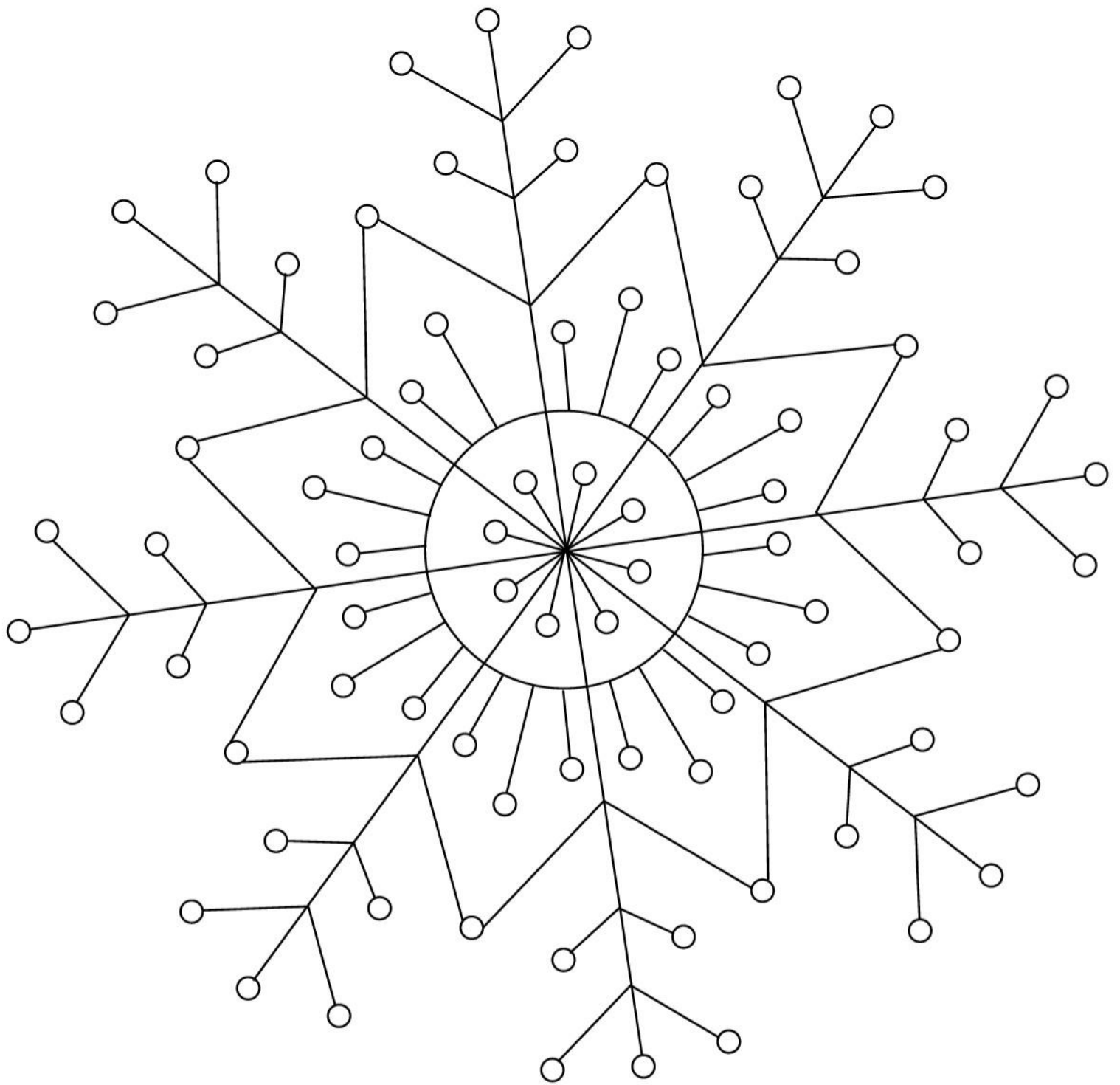

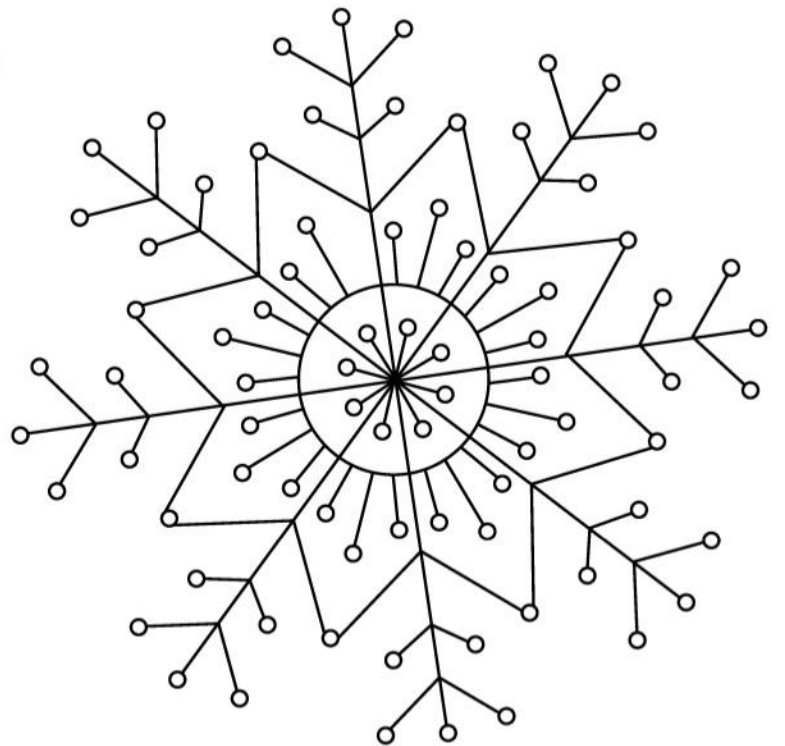
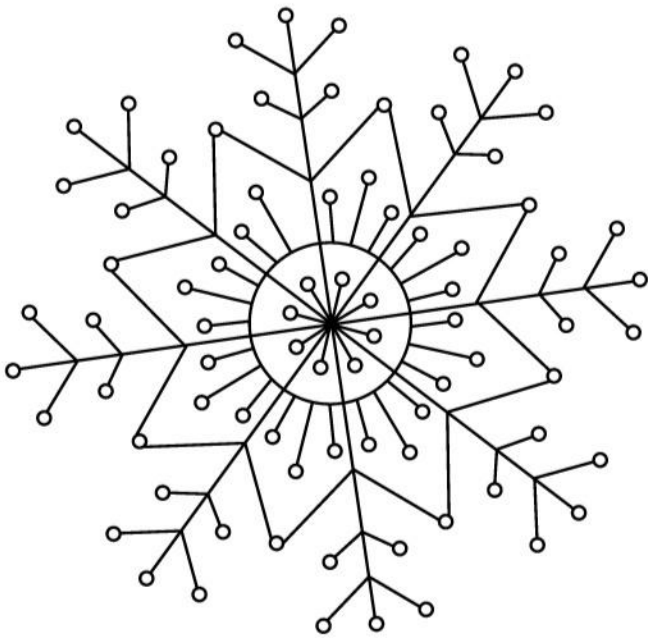
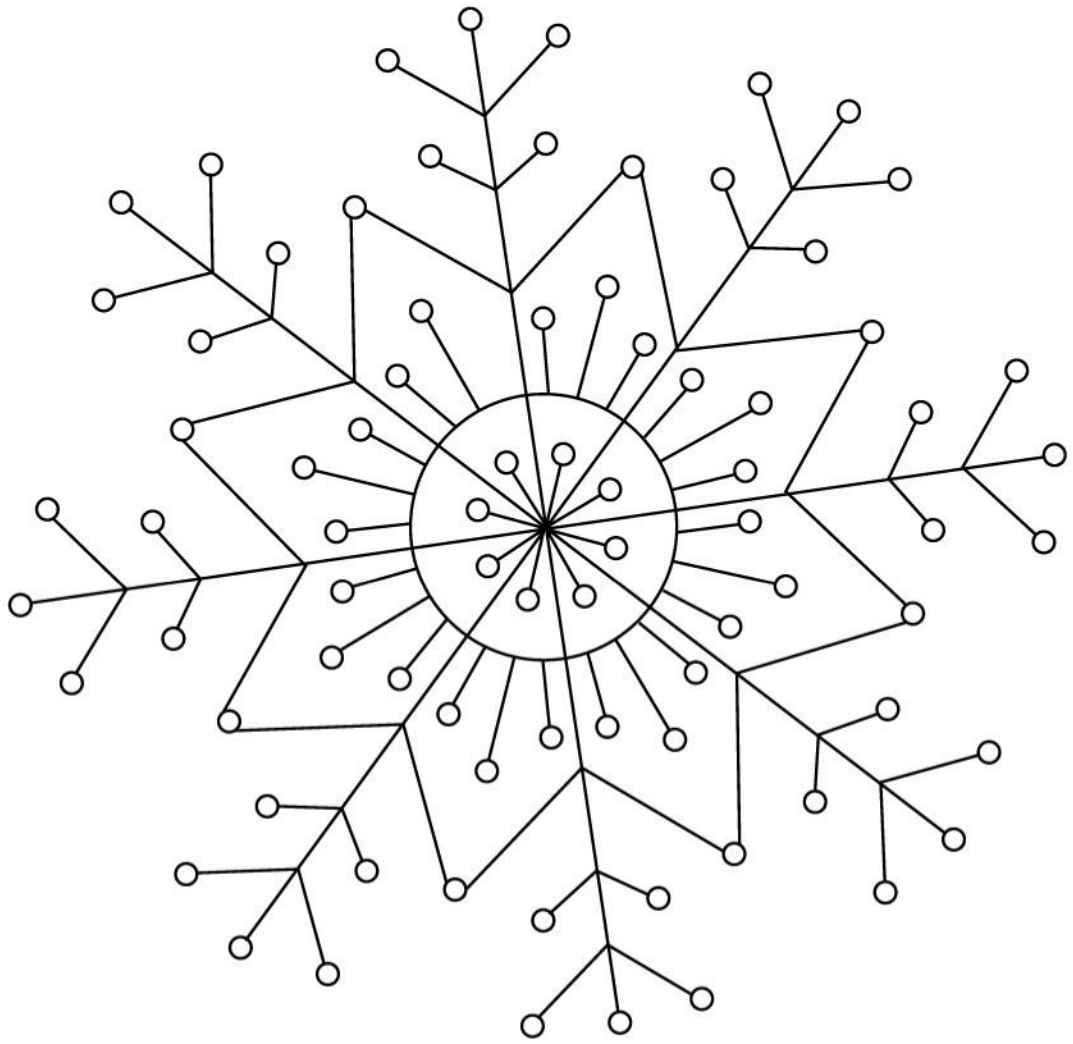

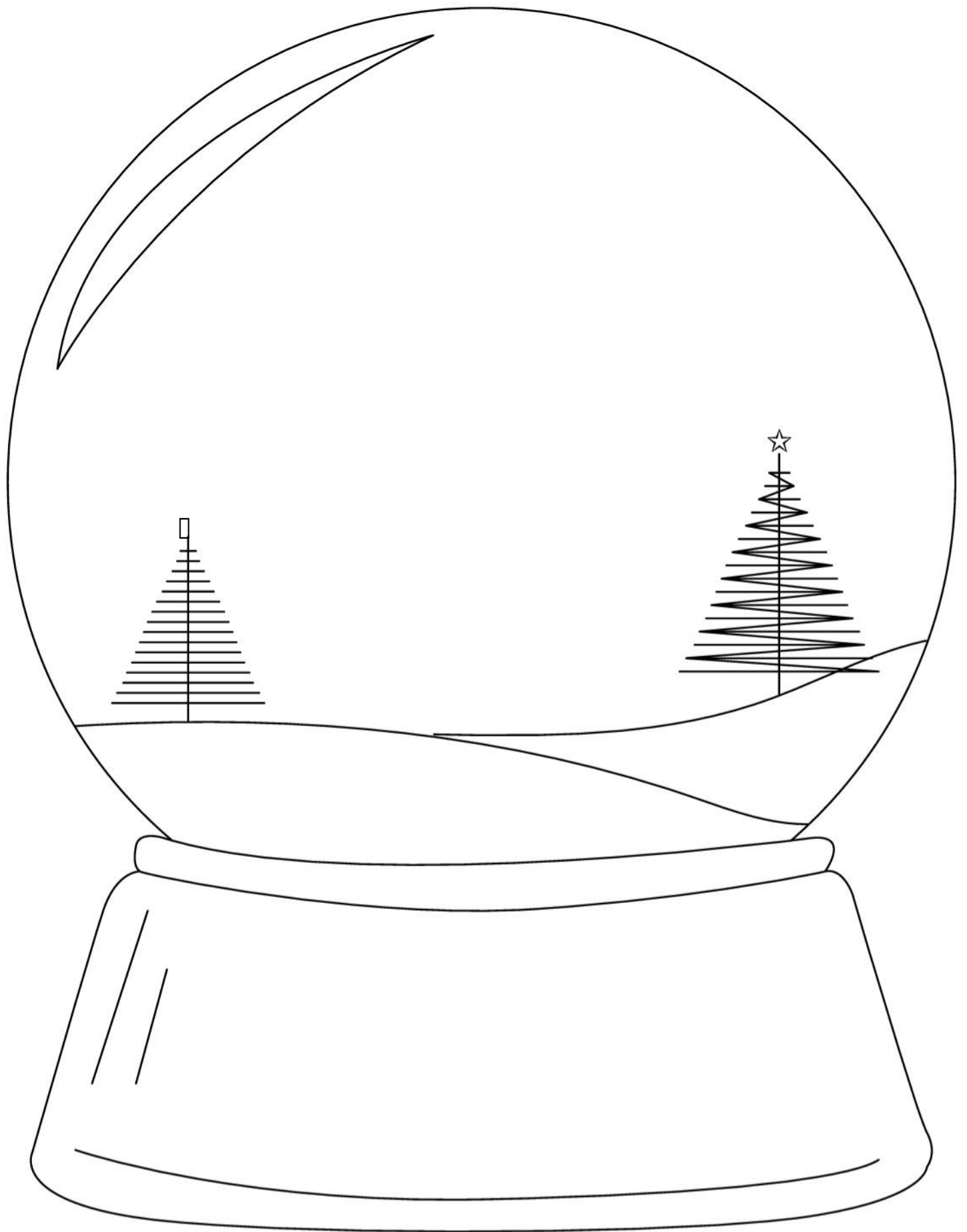

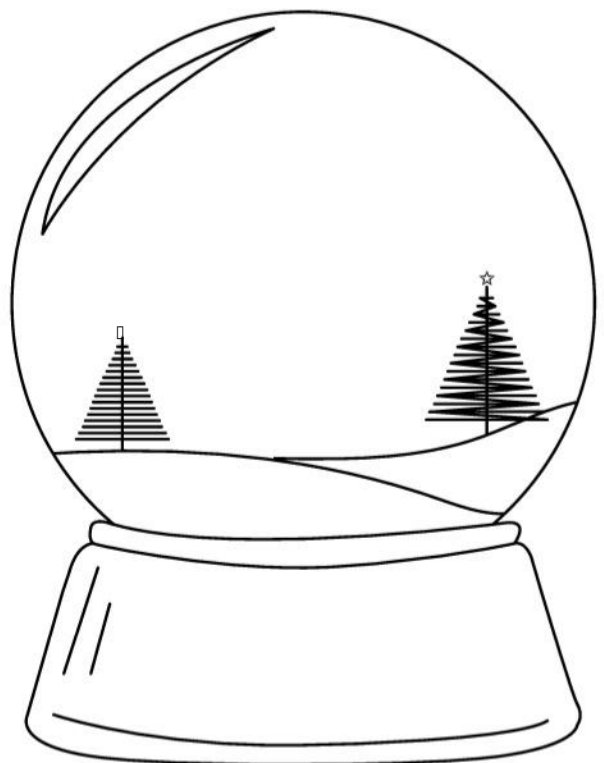
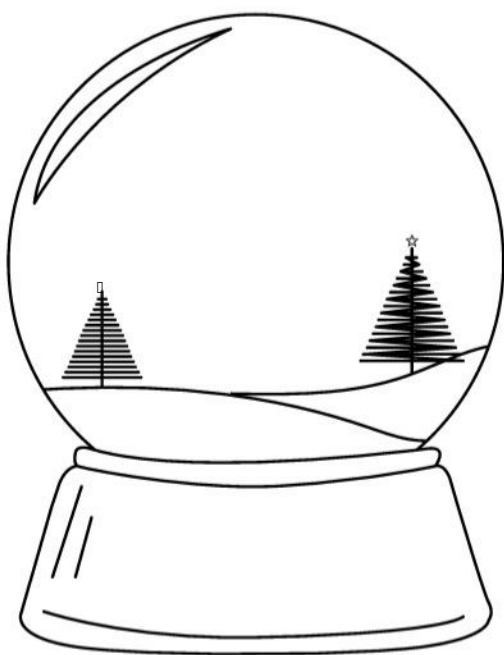
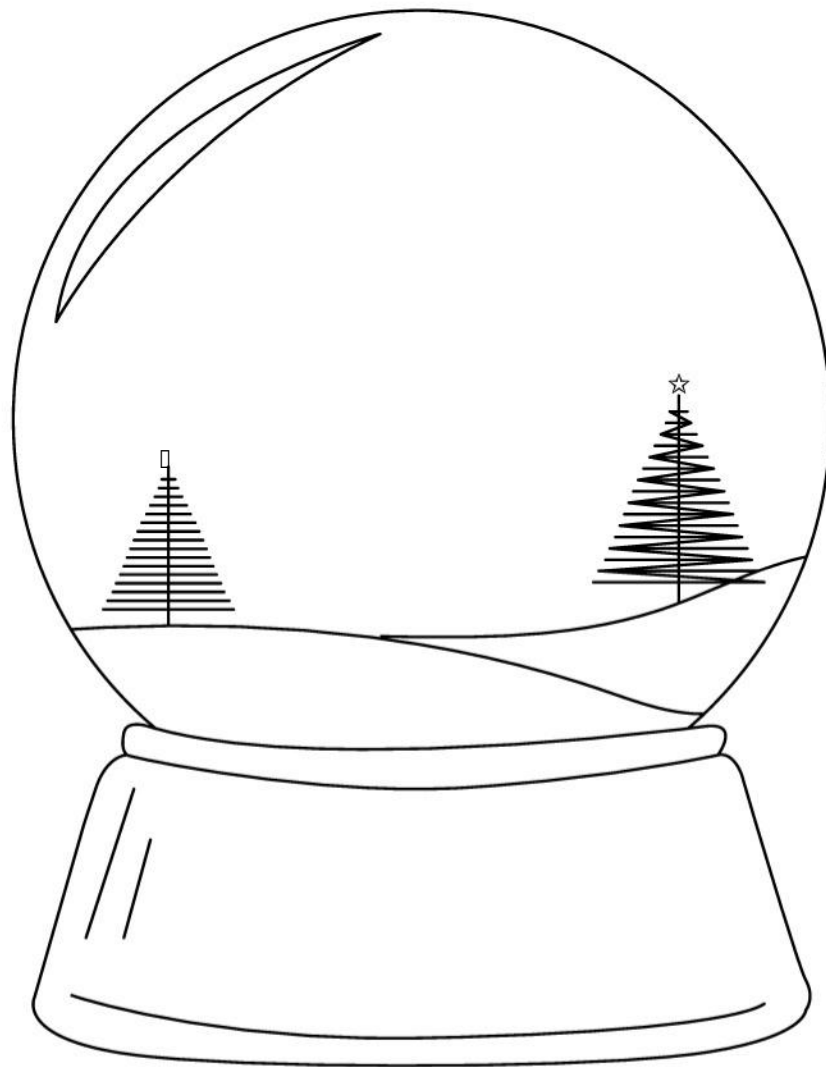

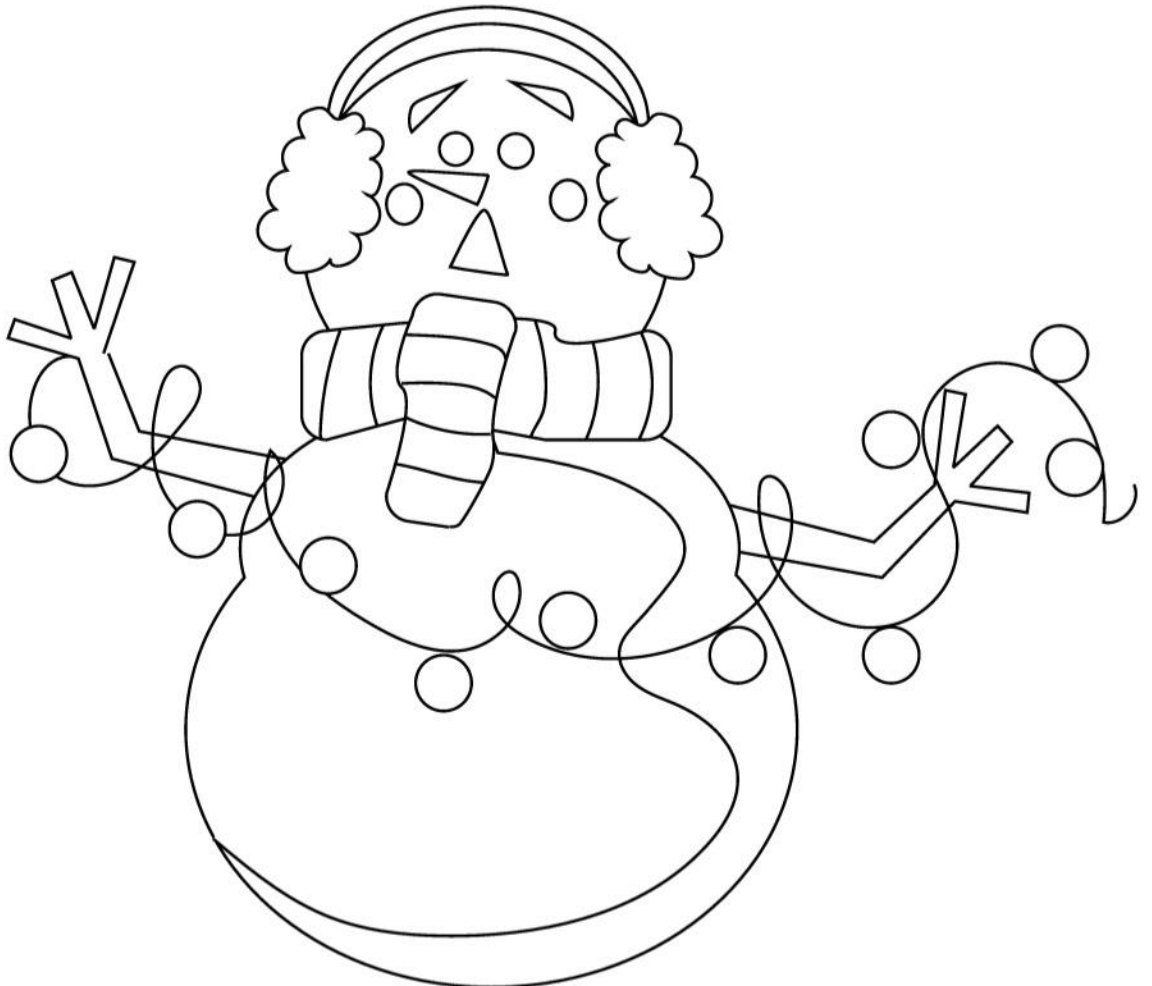

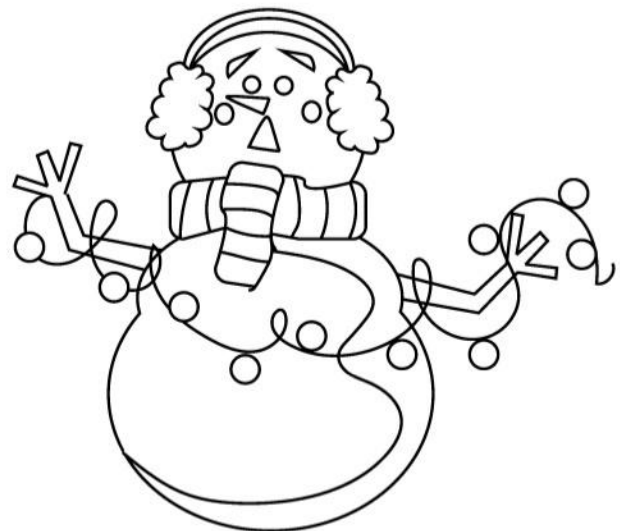

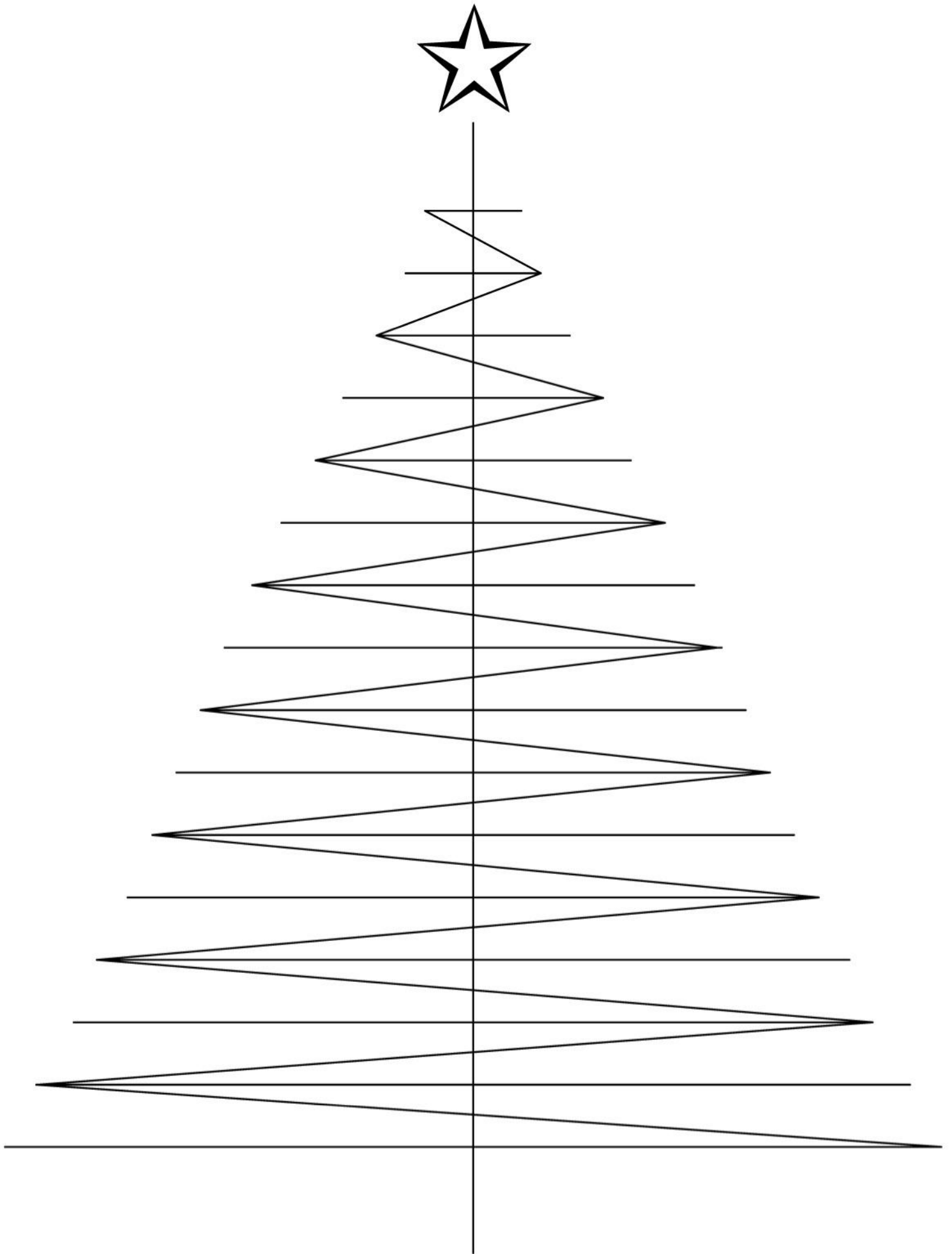

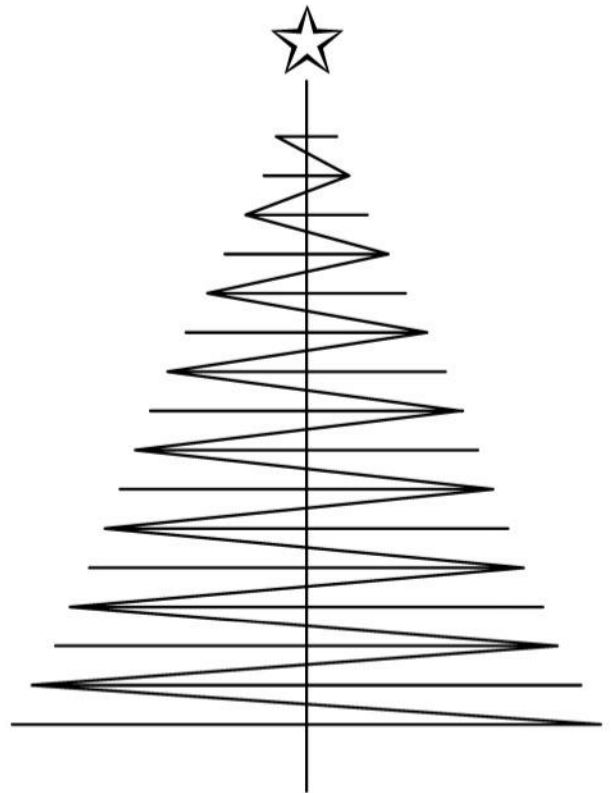
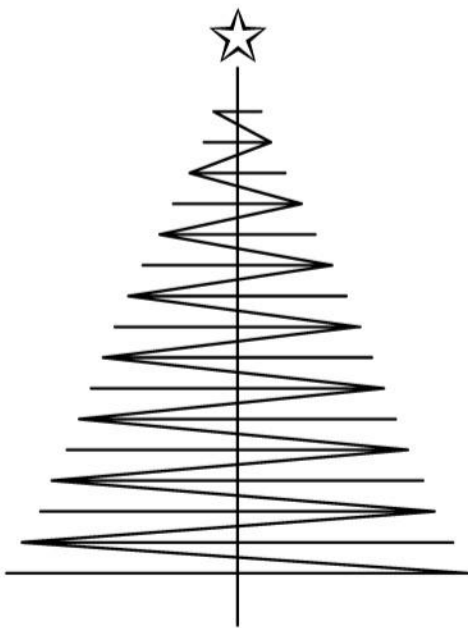
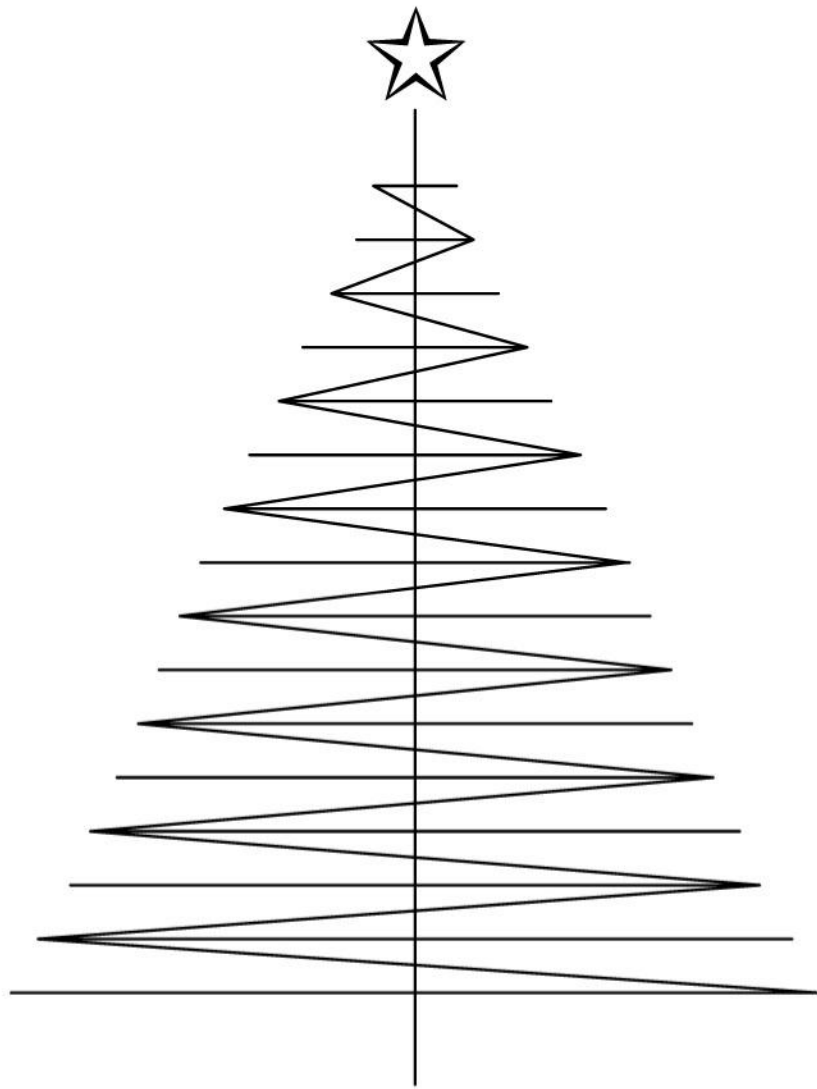

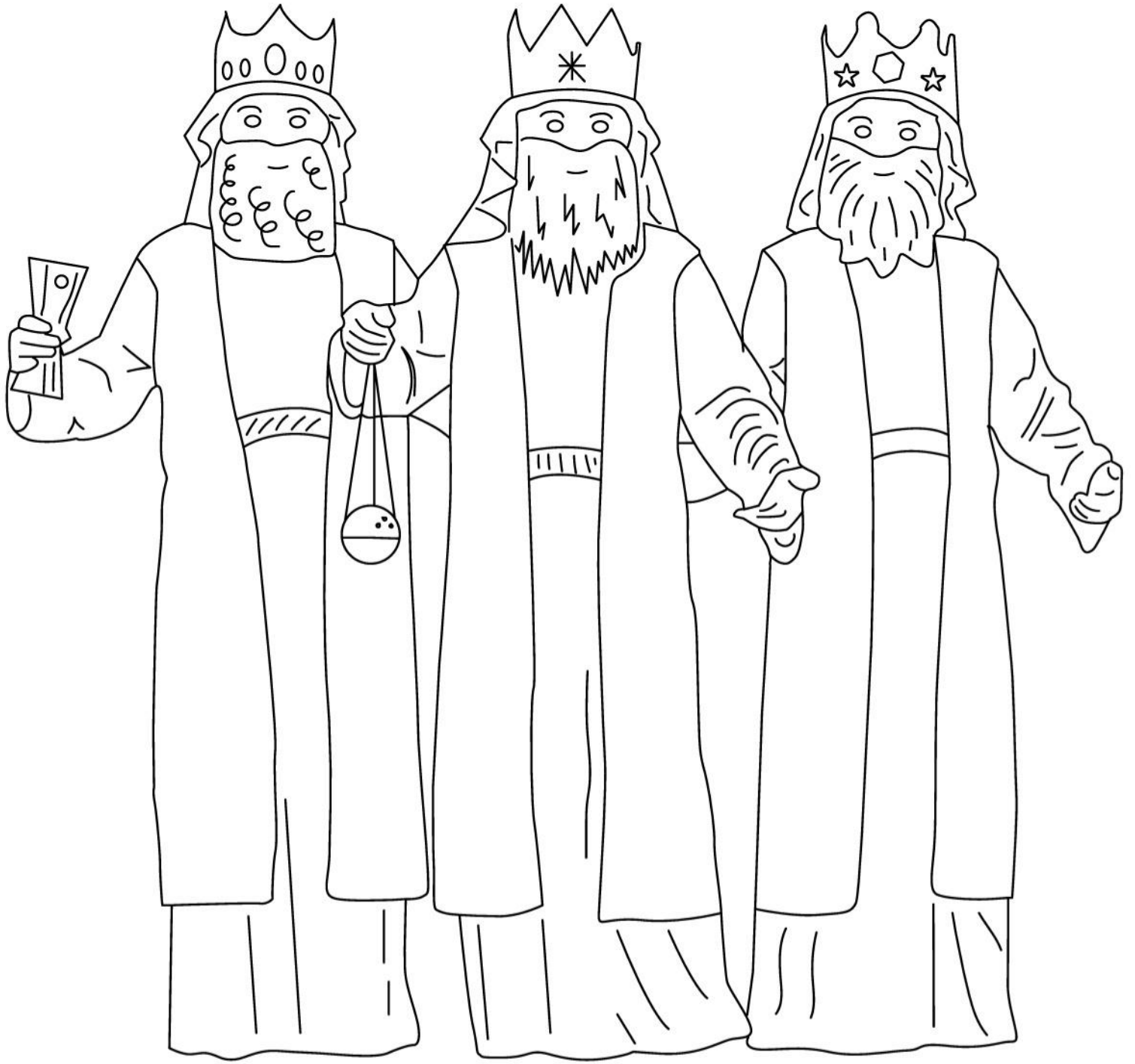

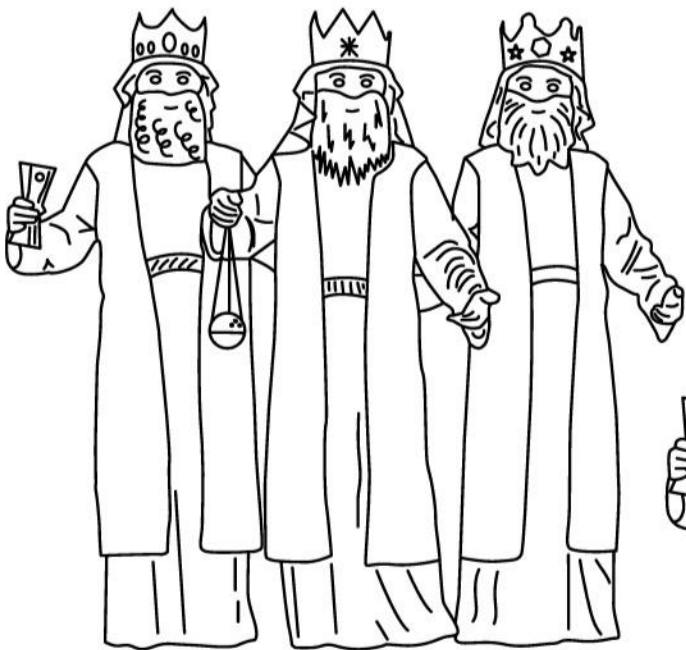
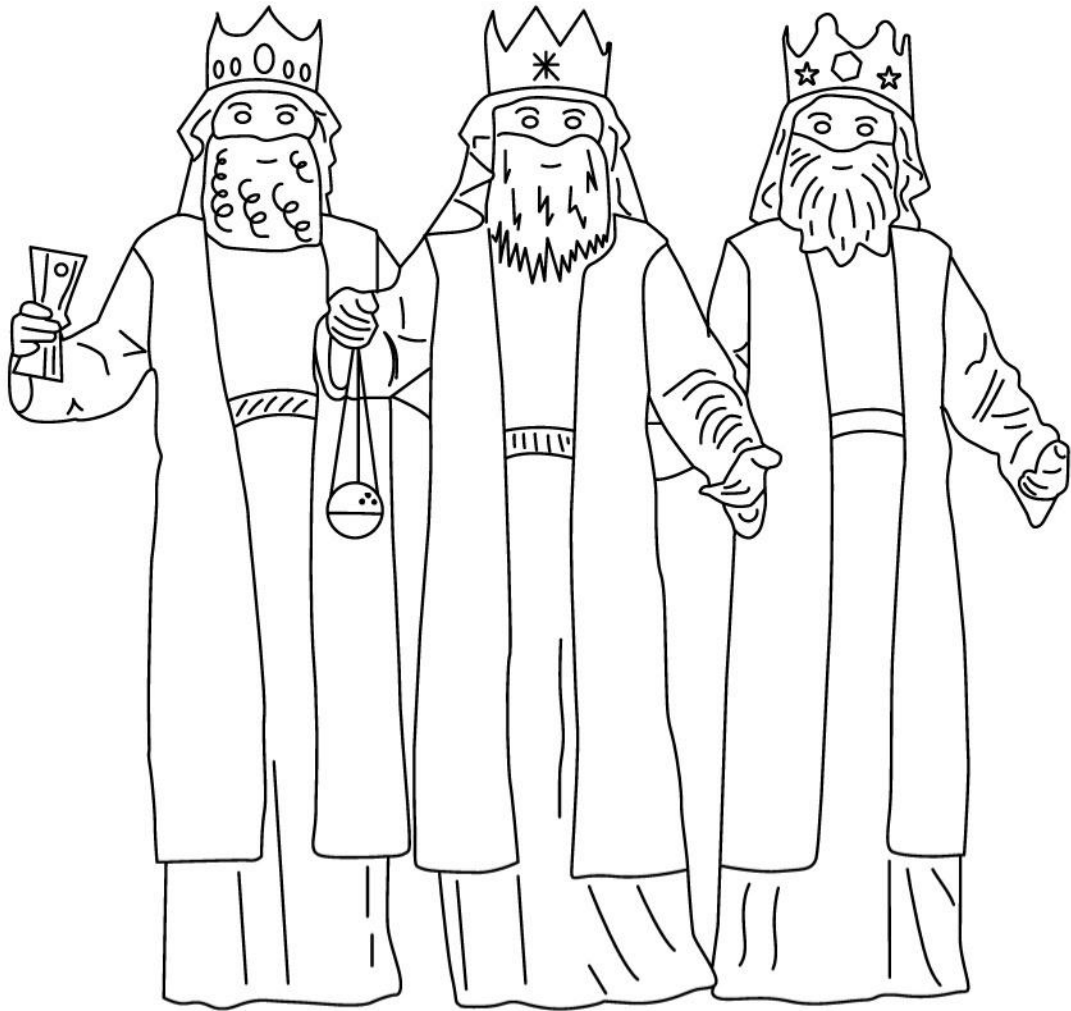

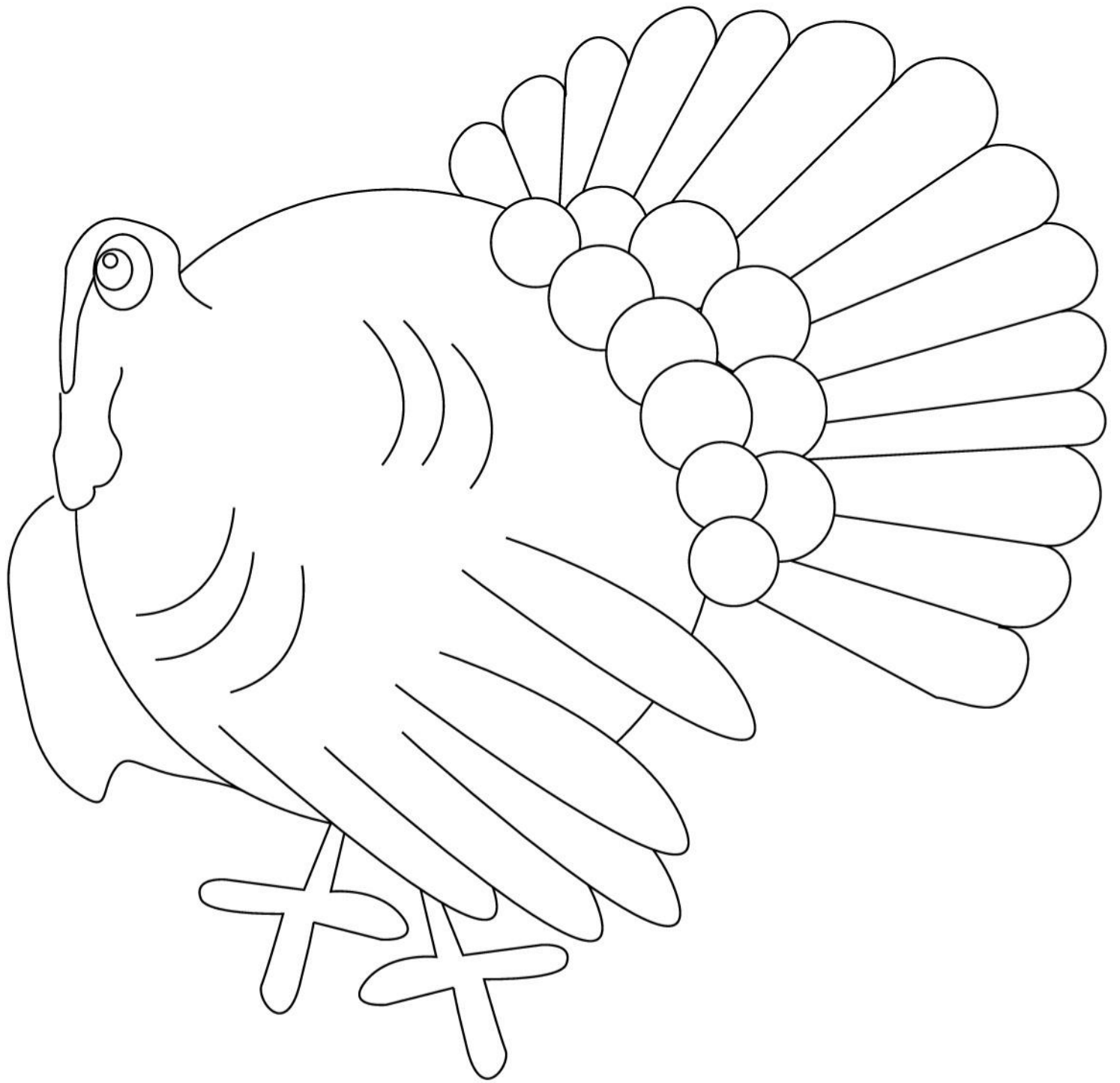

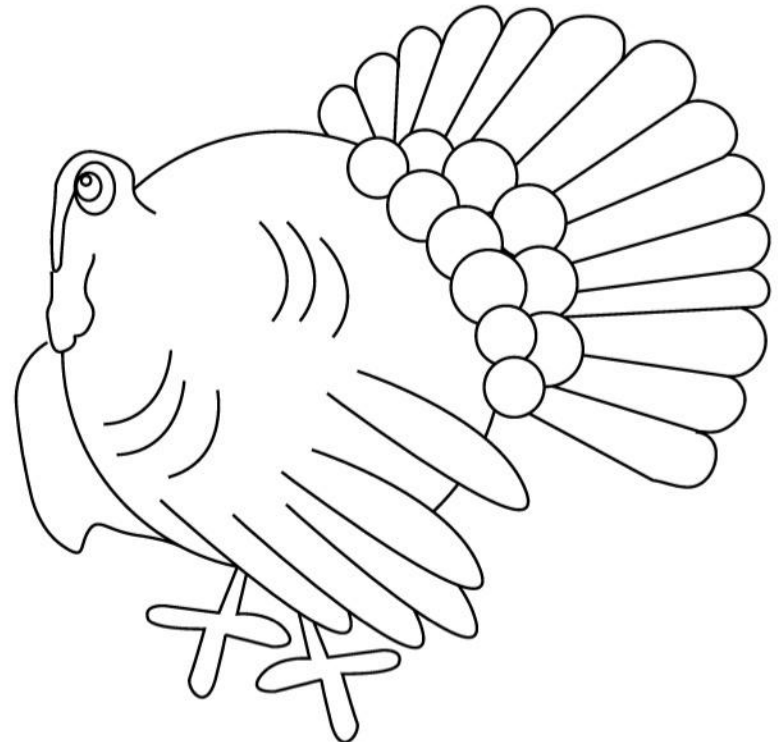
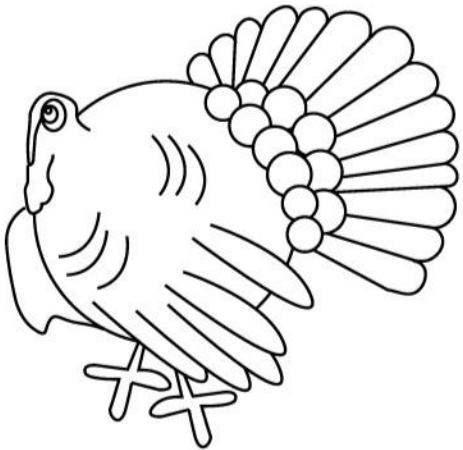
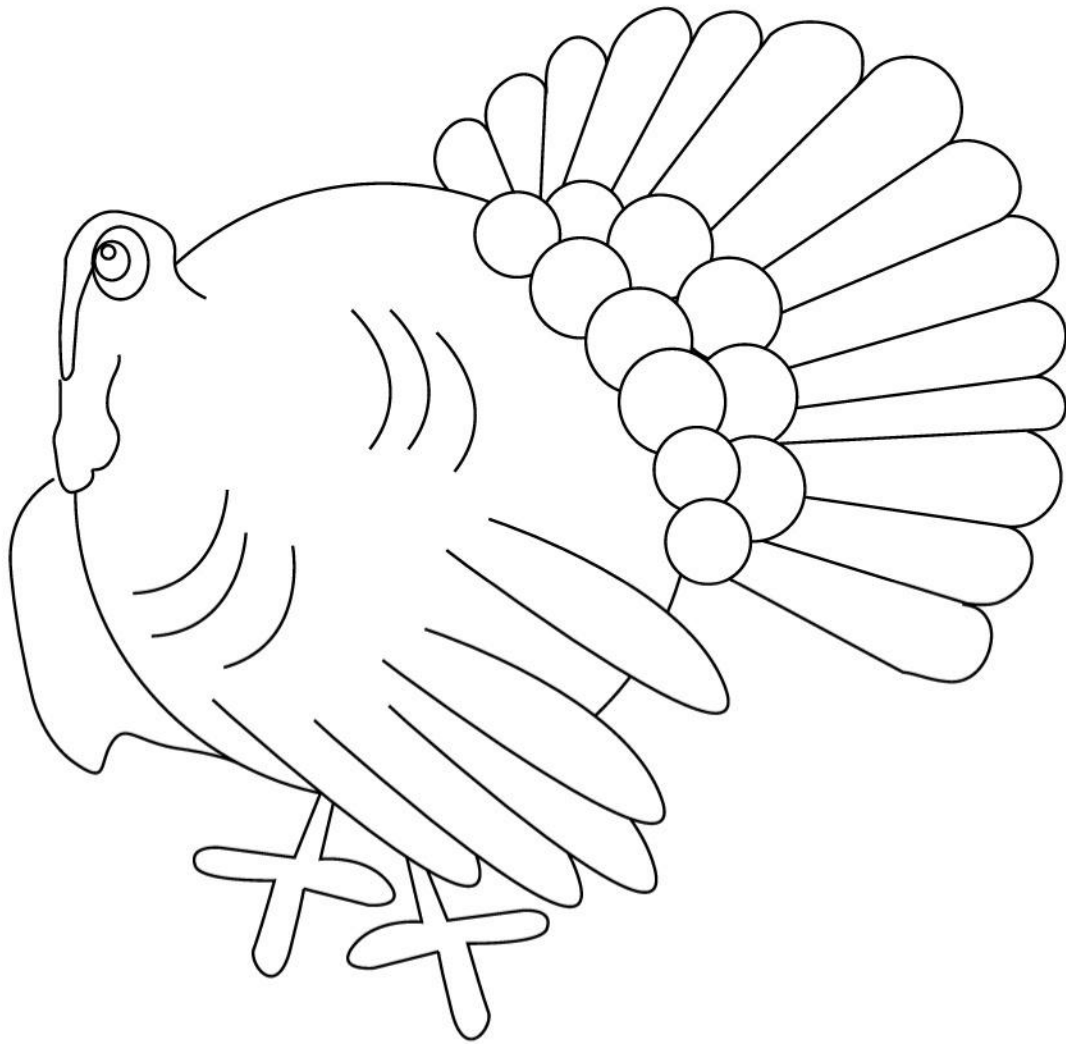





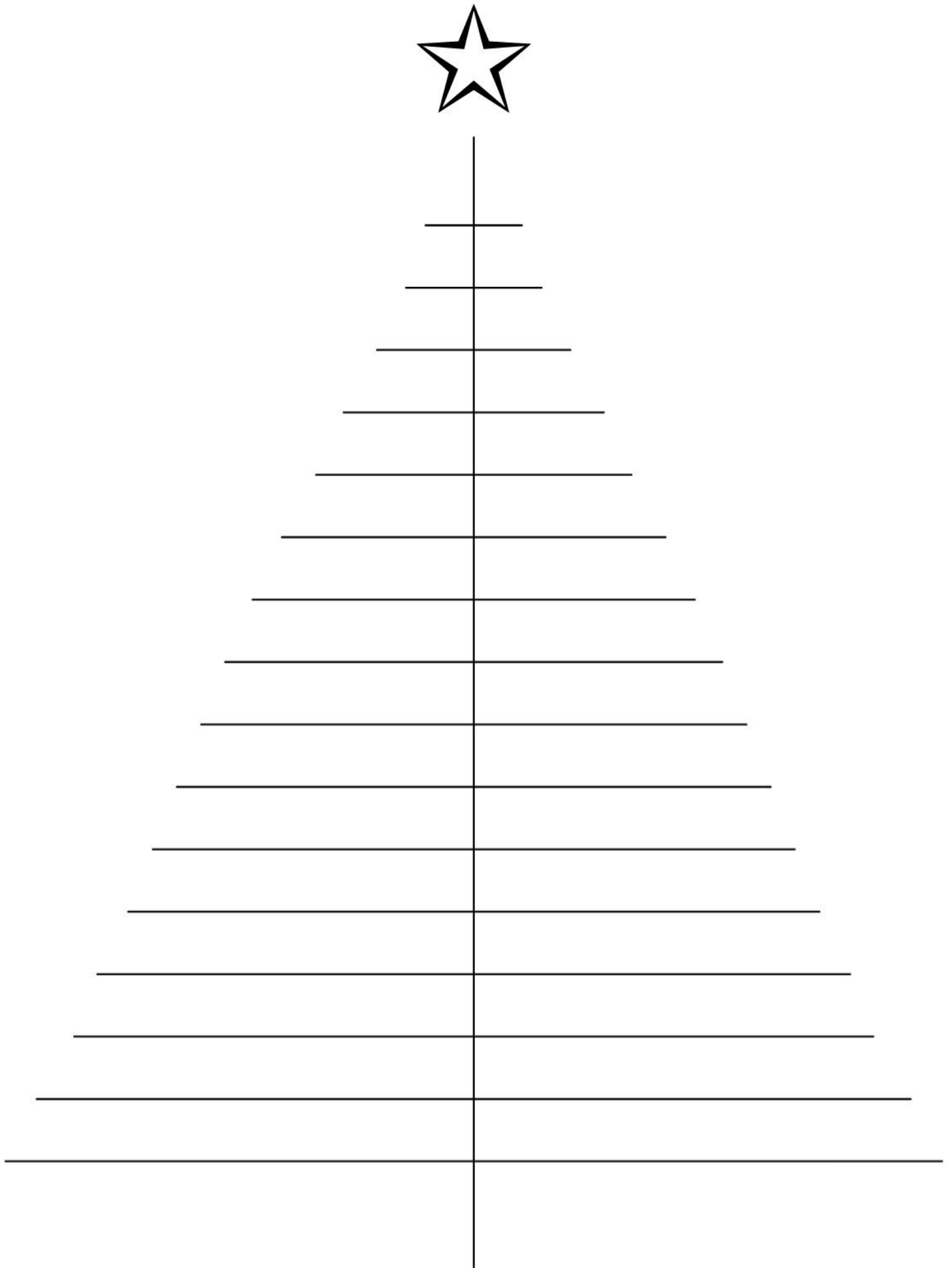

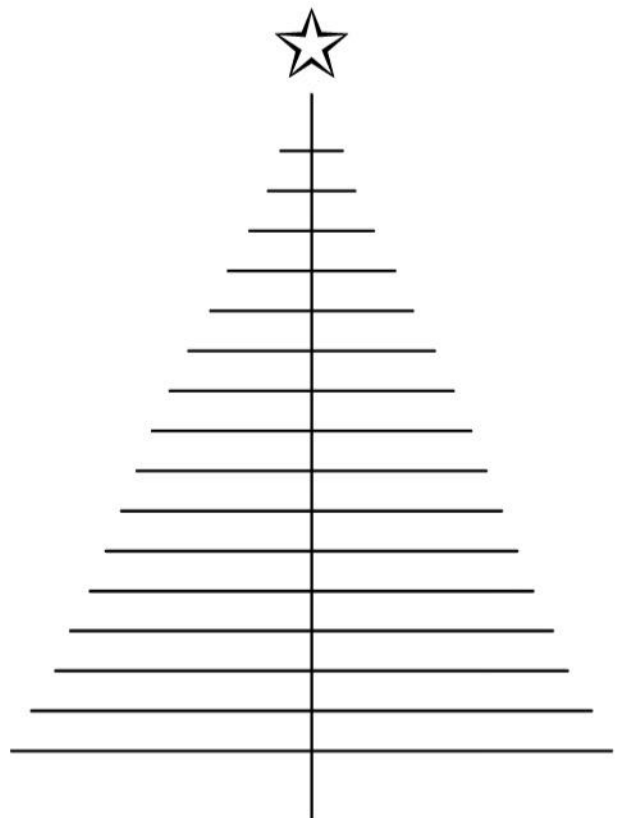
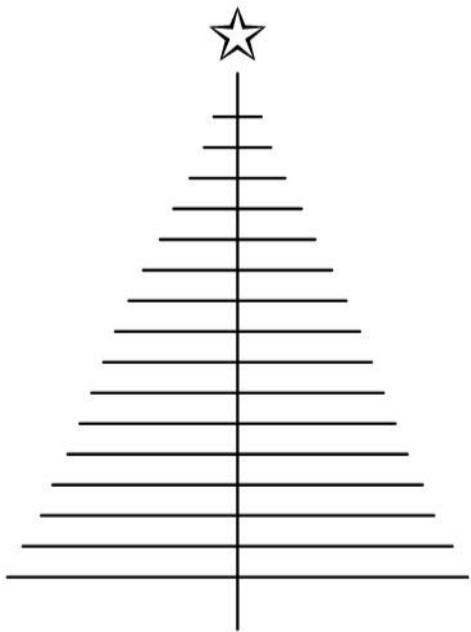
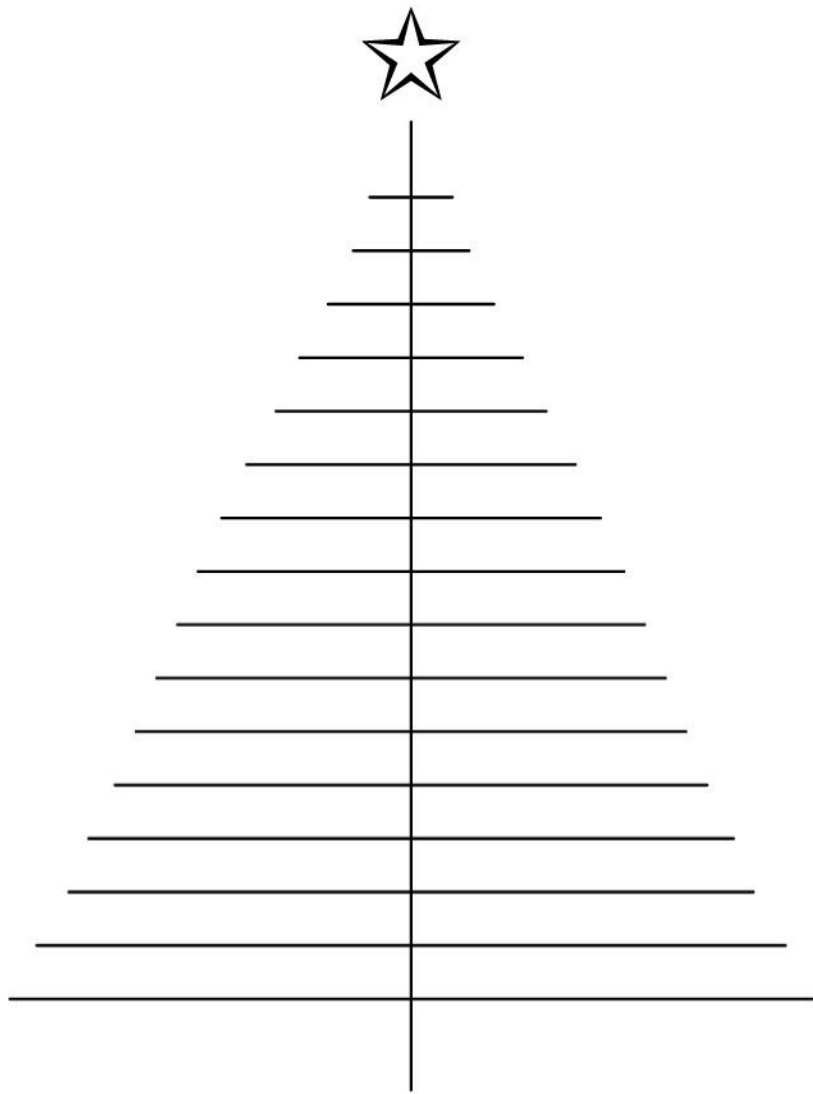





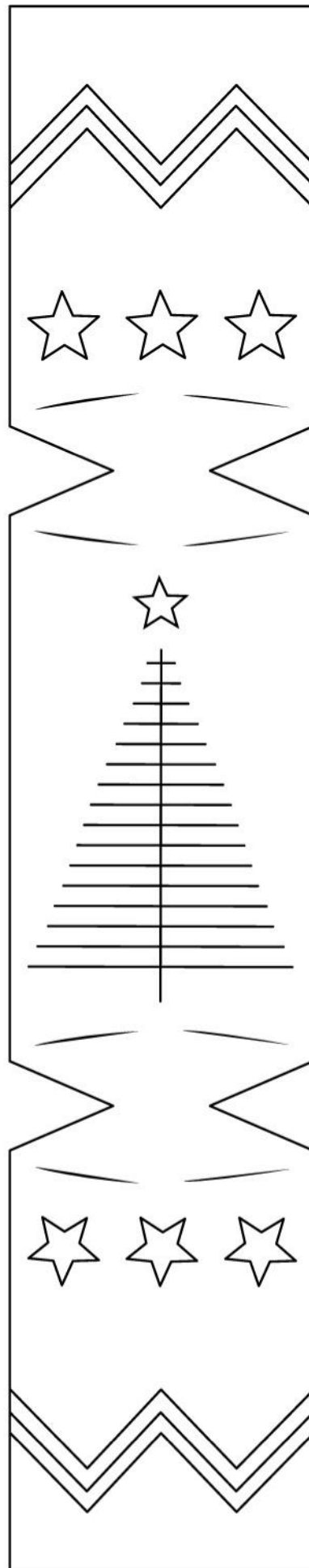
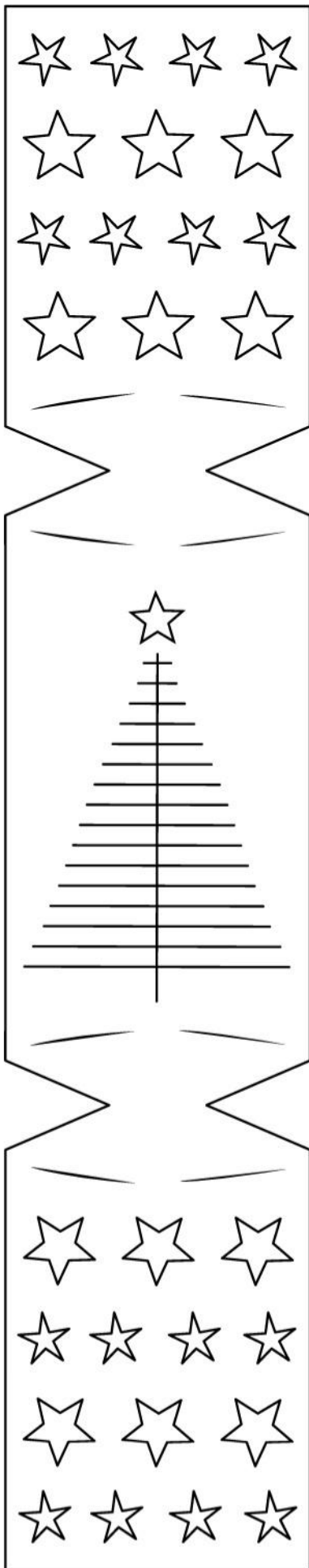

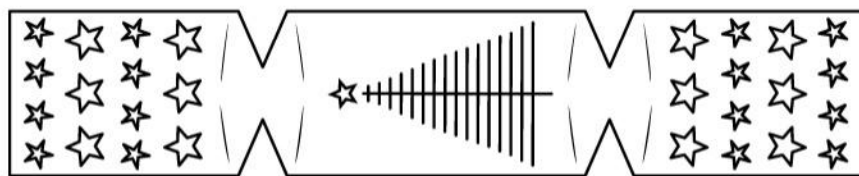
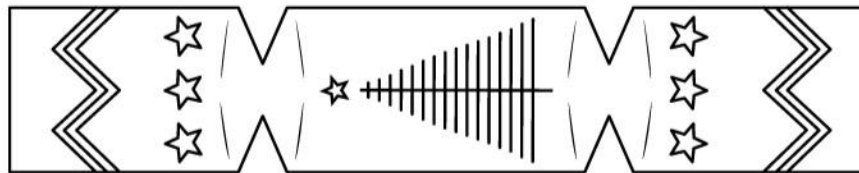
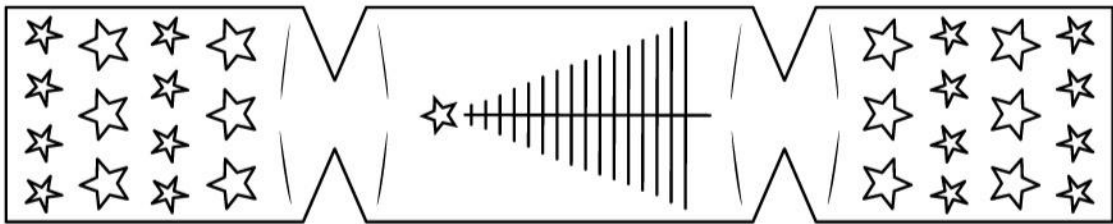
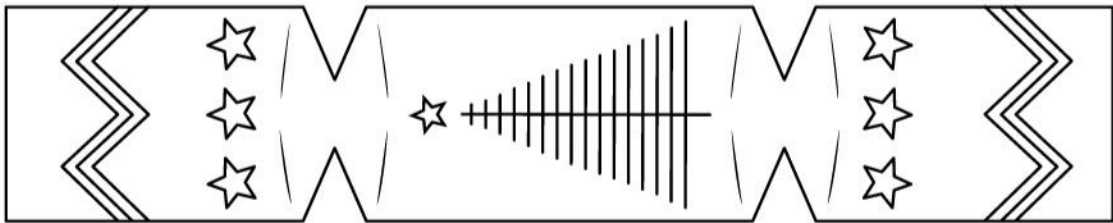
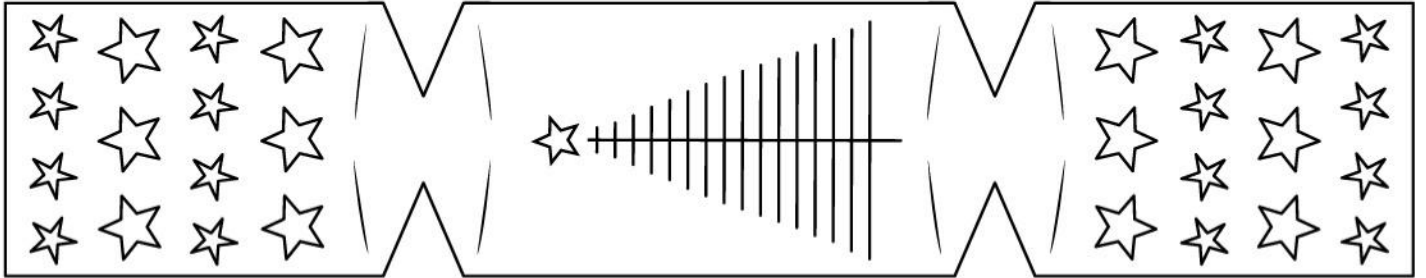
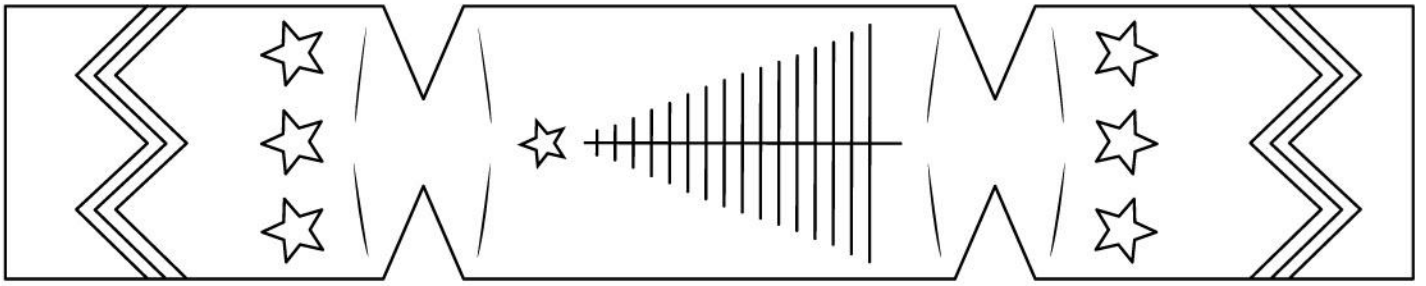



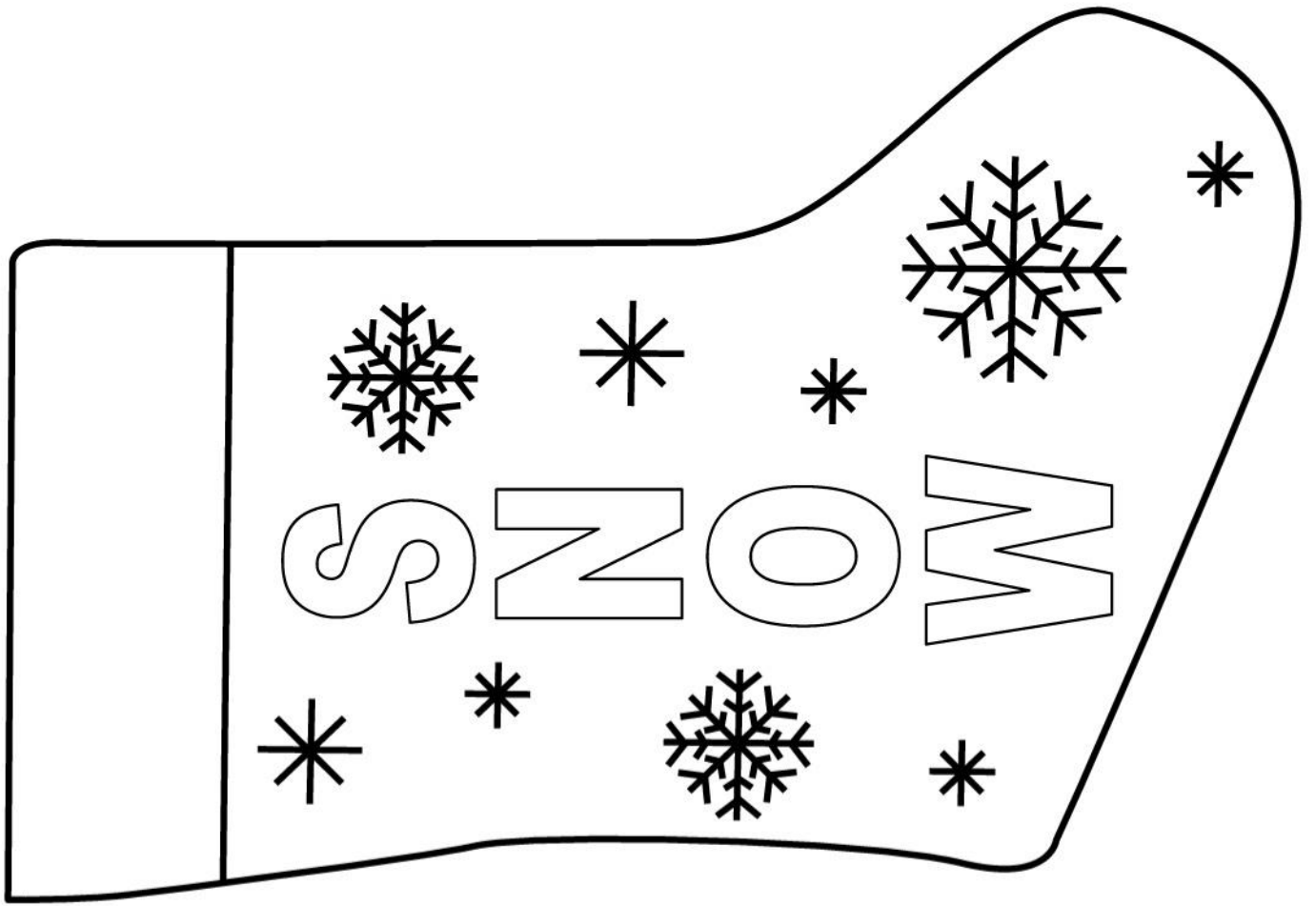

Dad

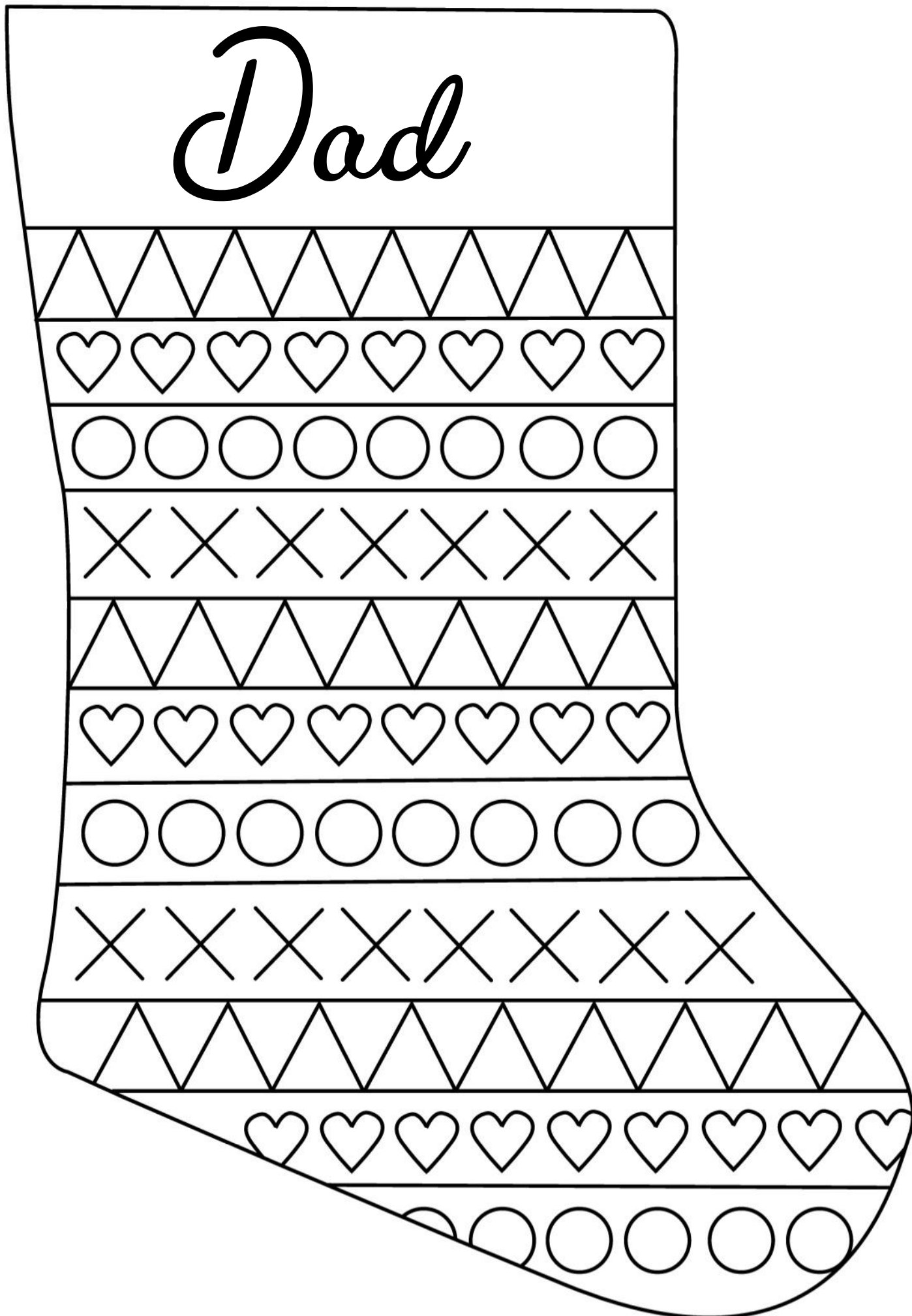

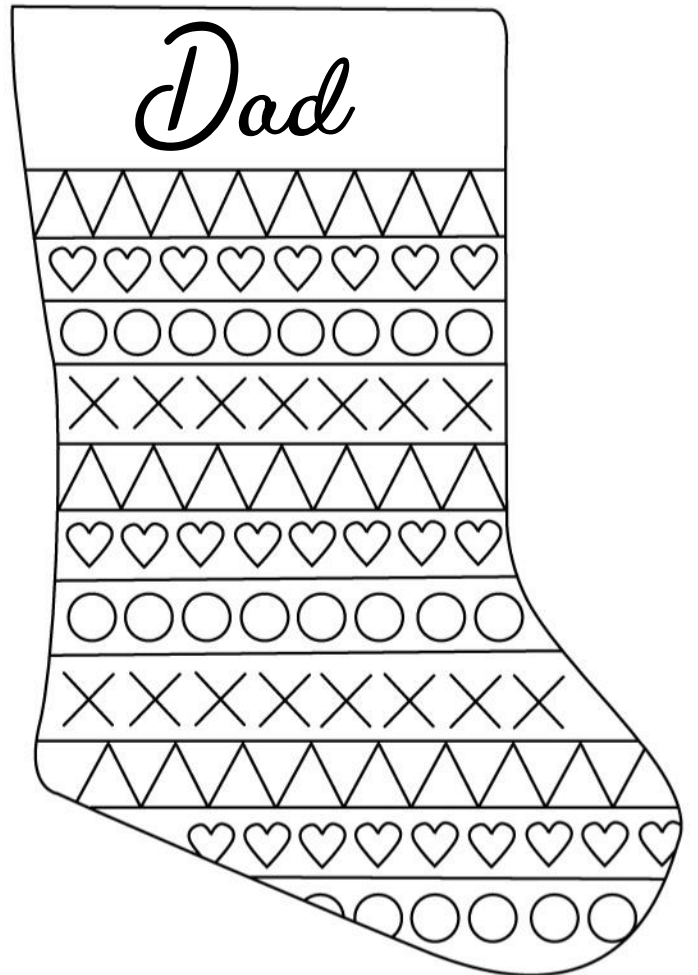
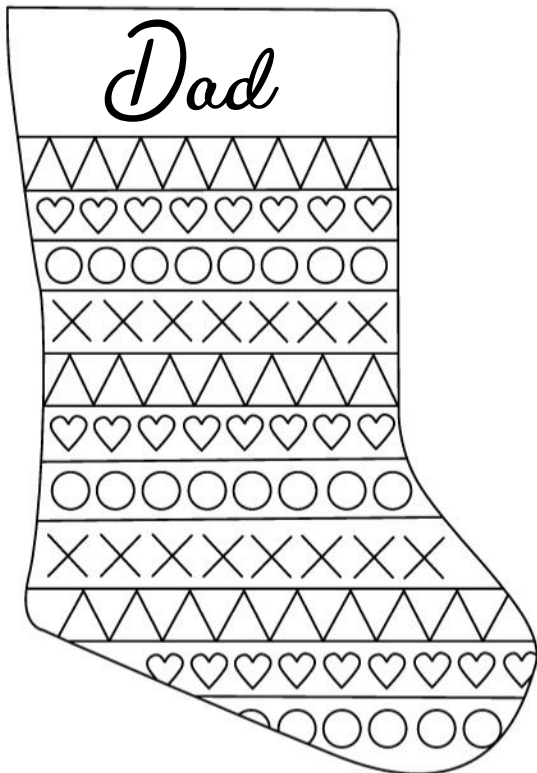
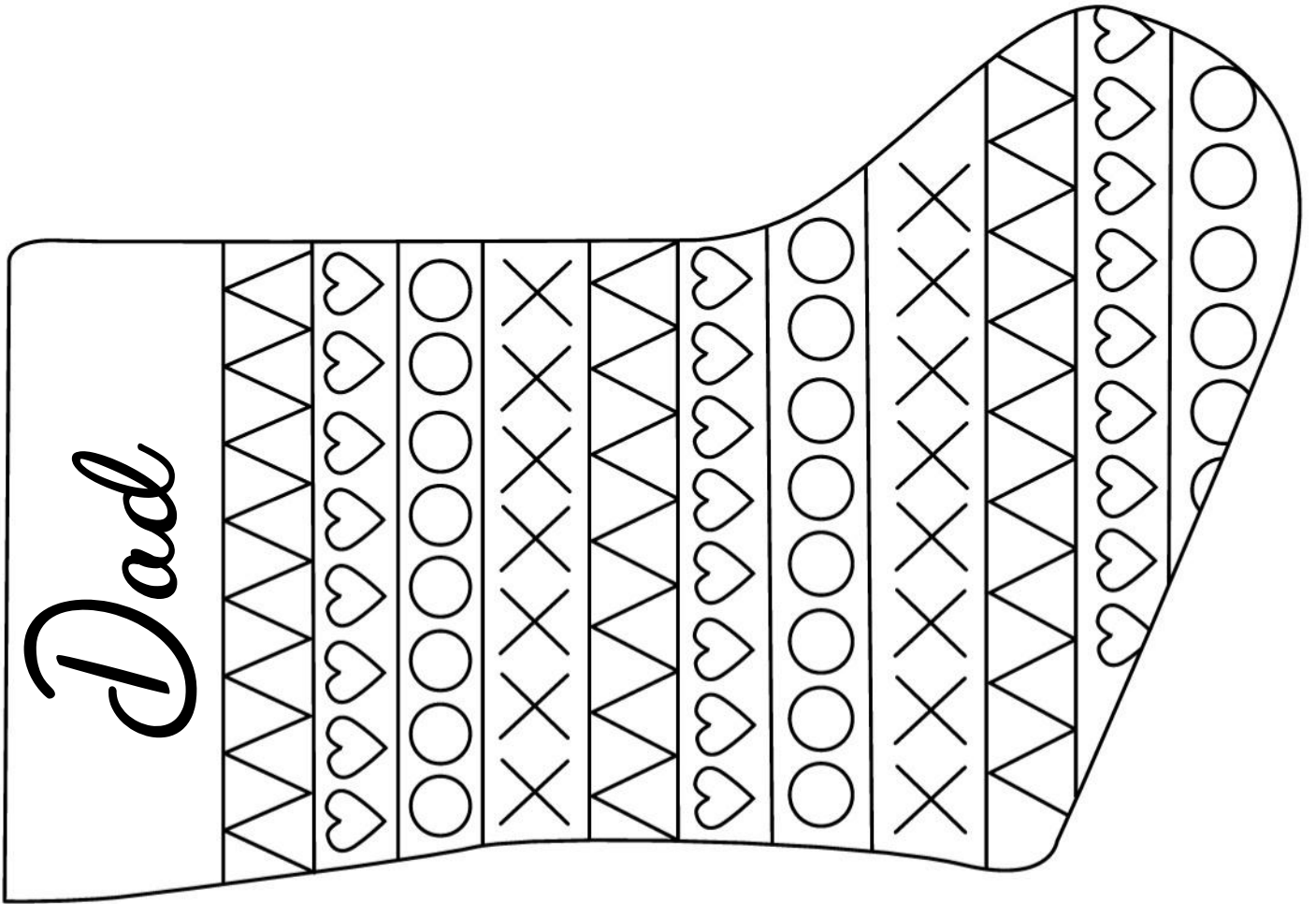

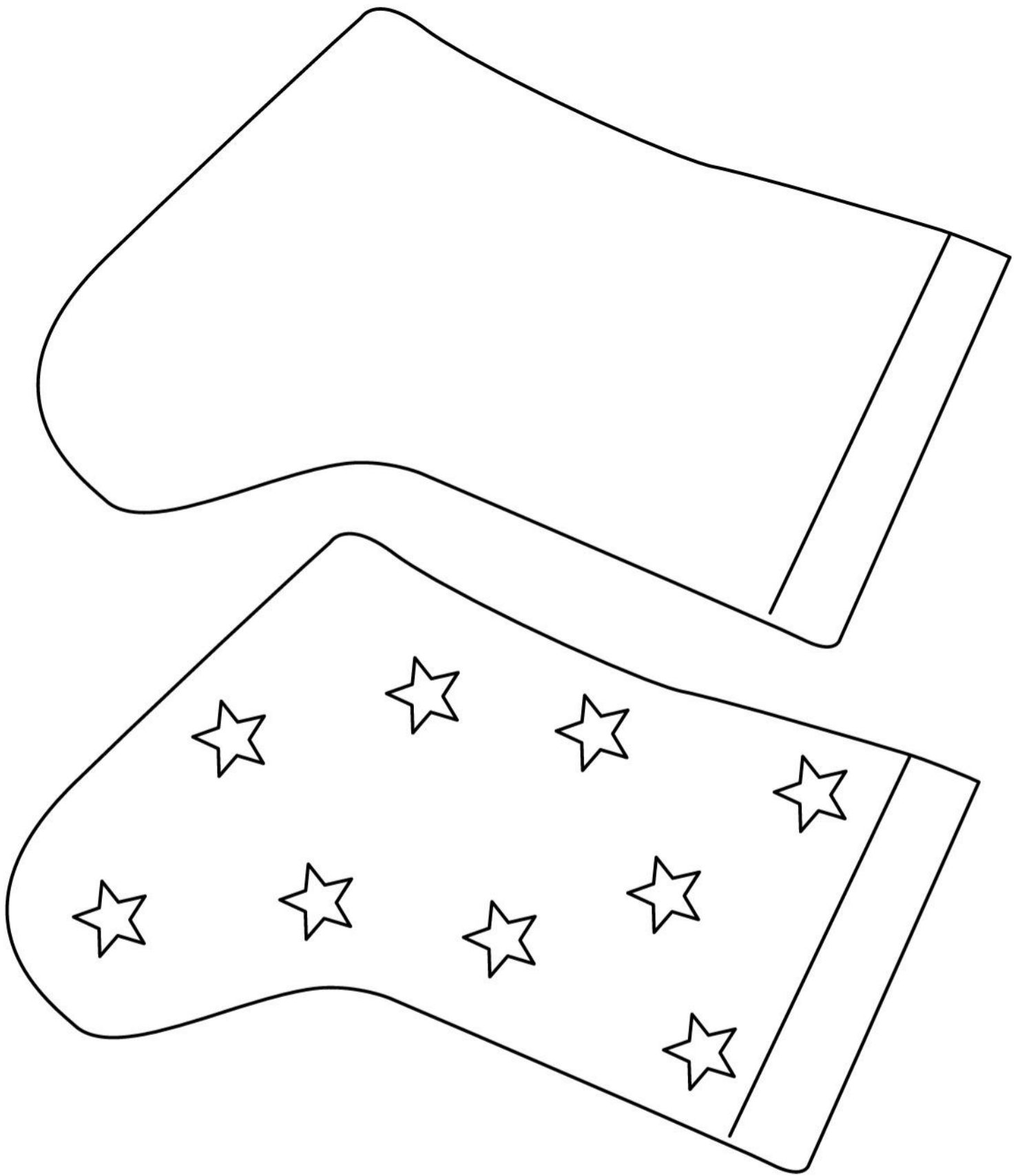



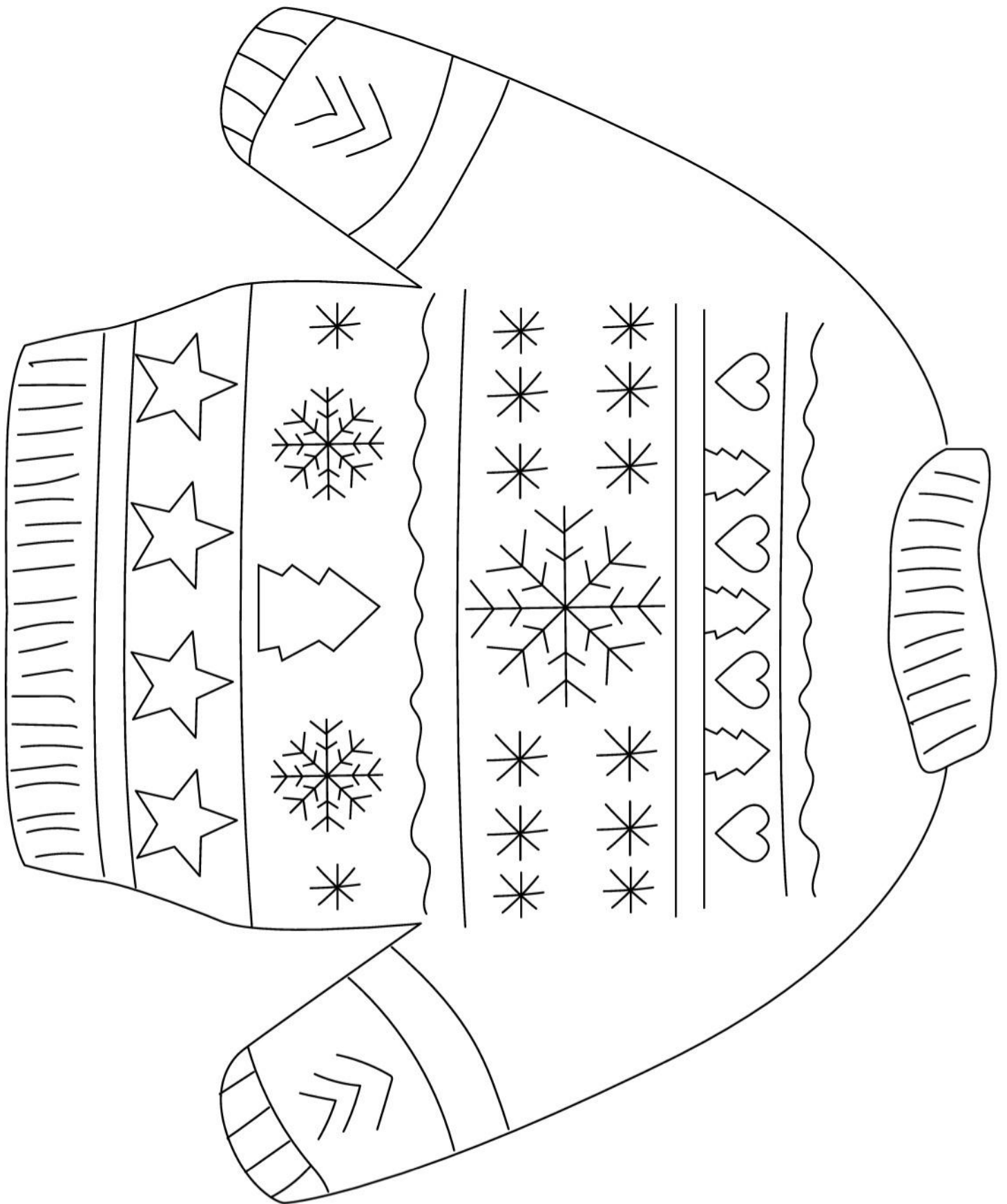



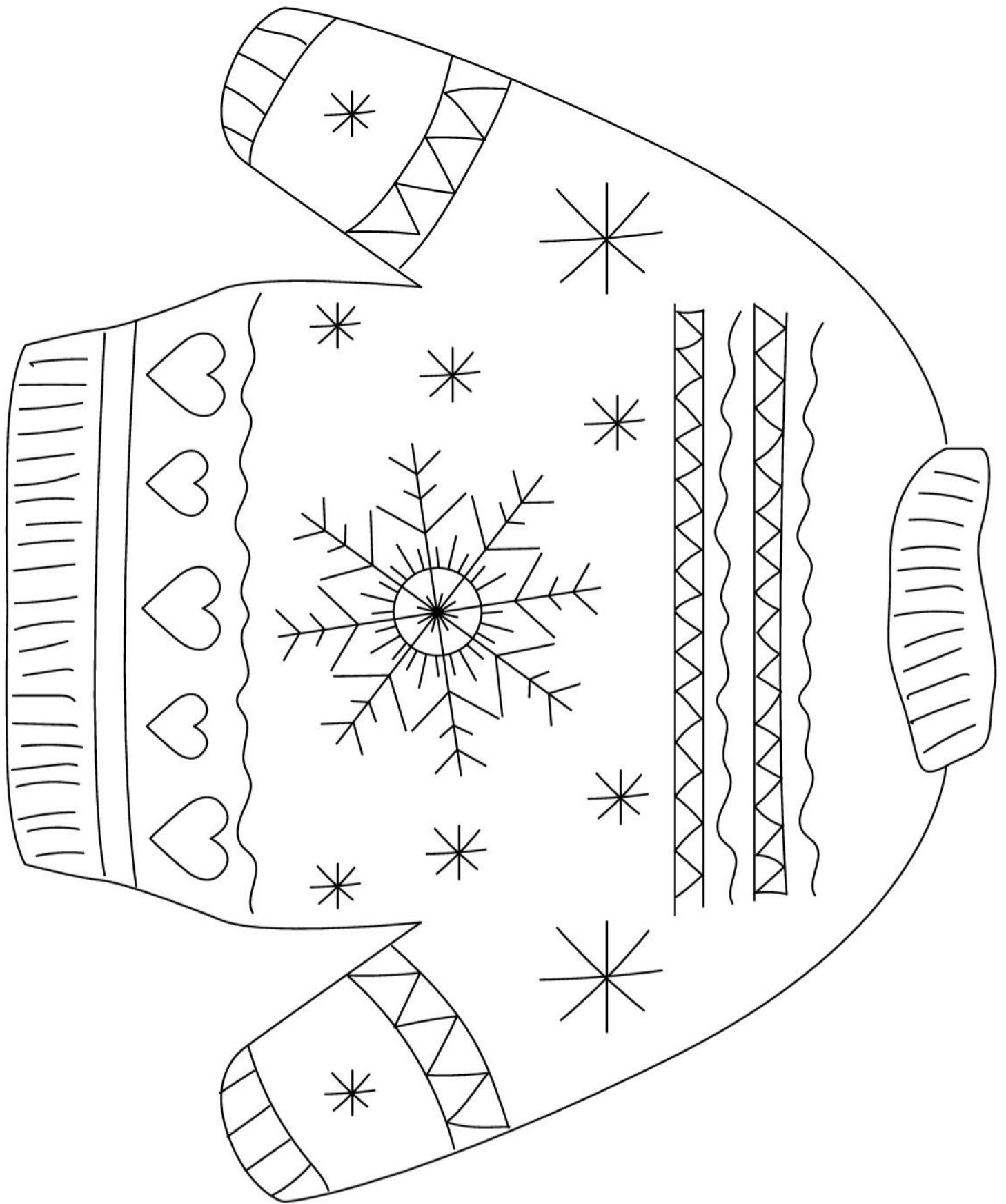



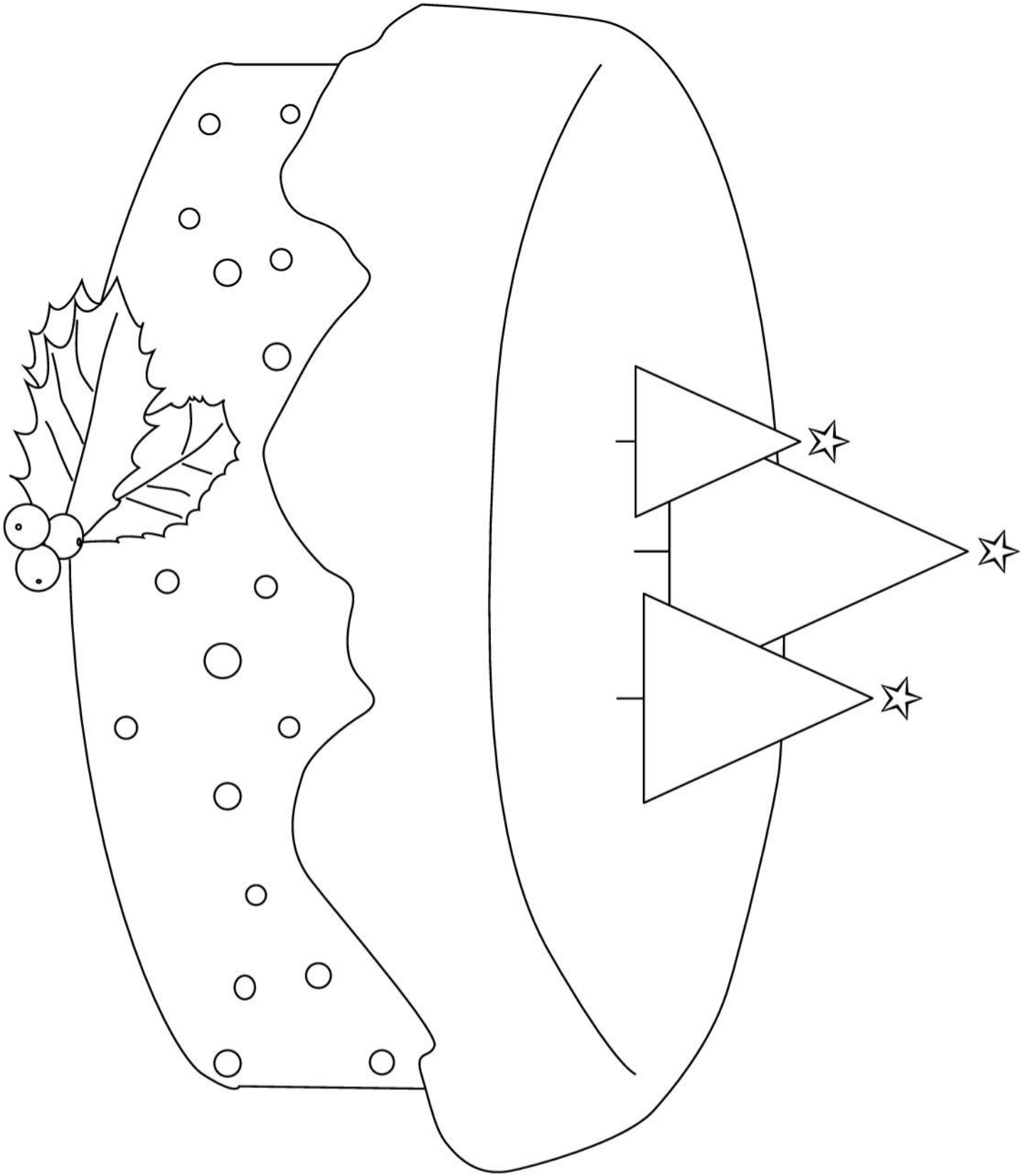

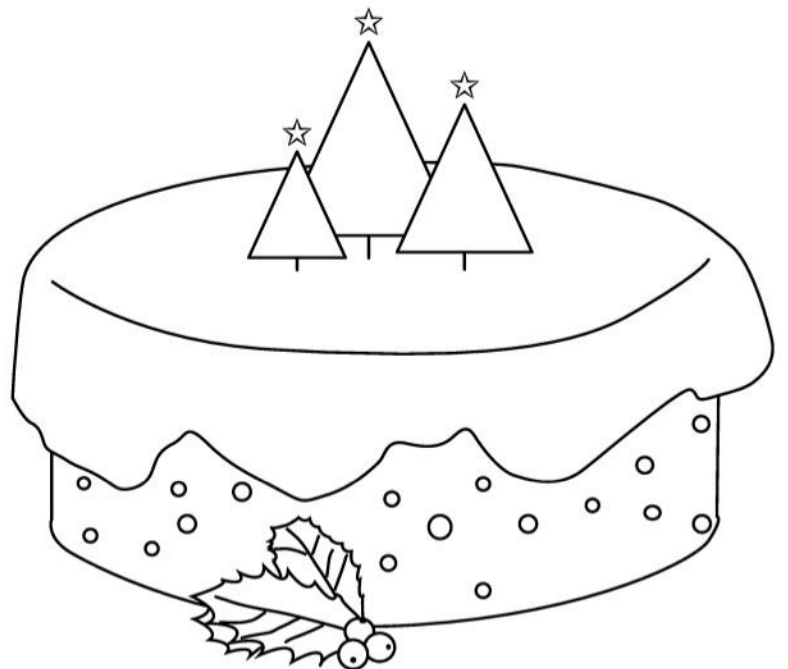
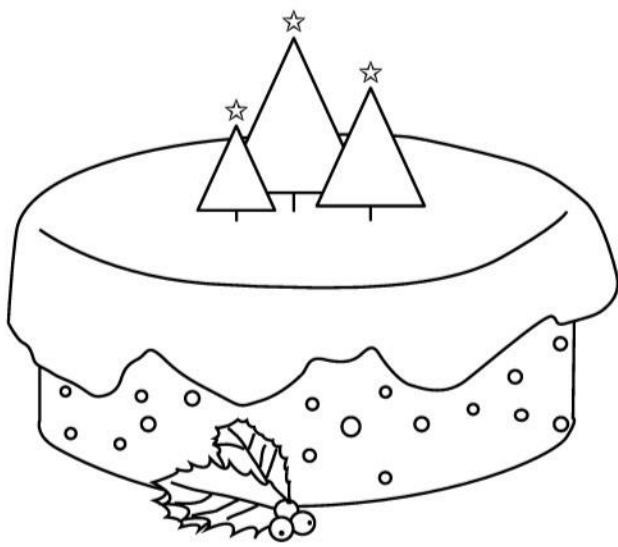
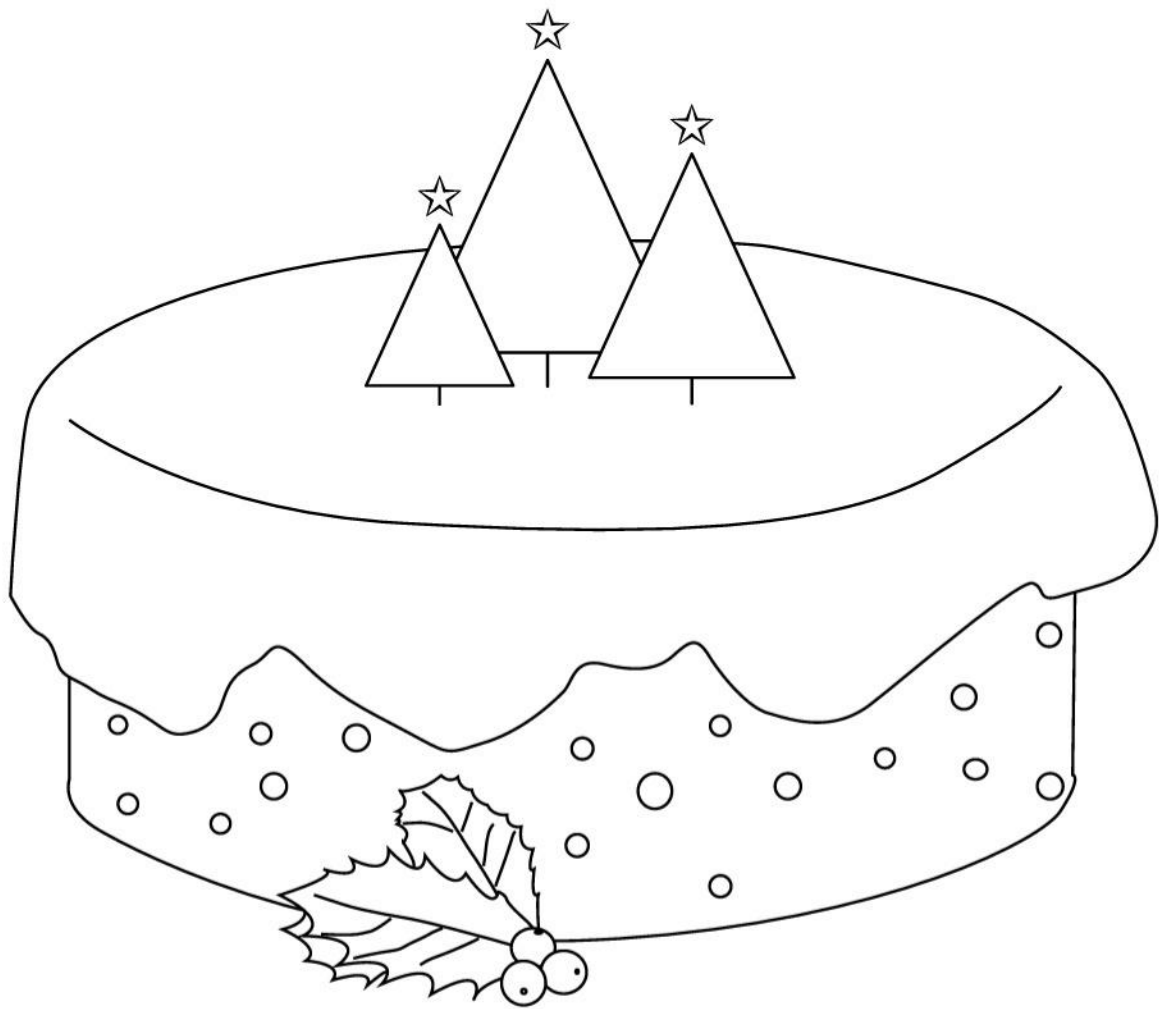

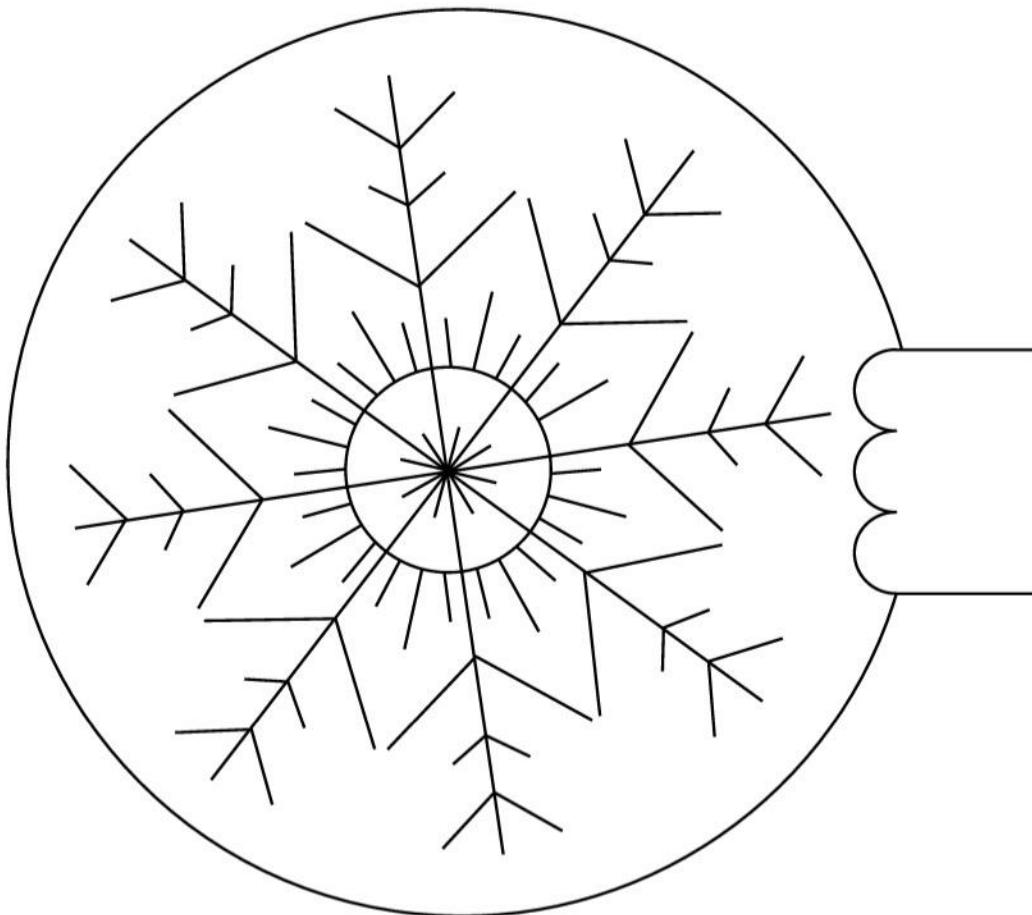
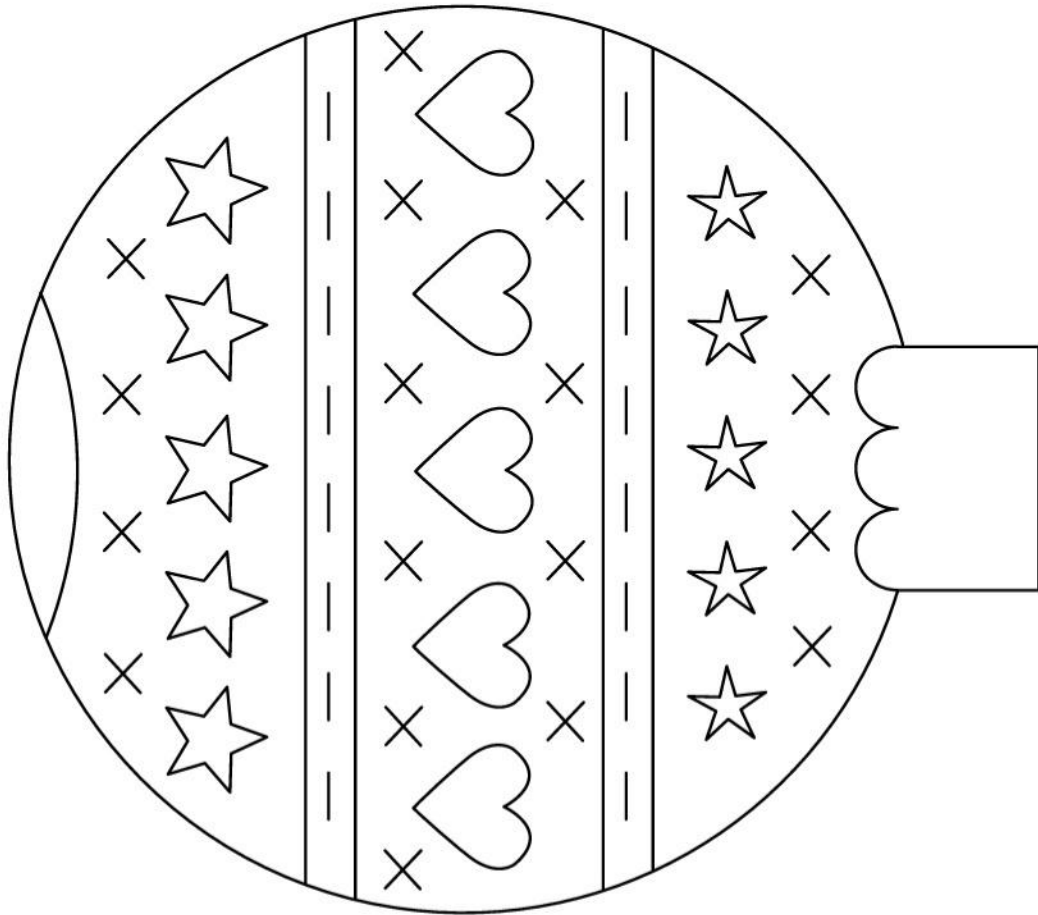

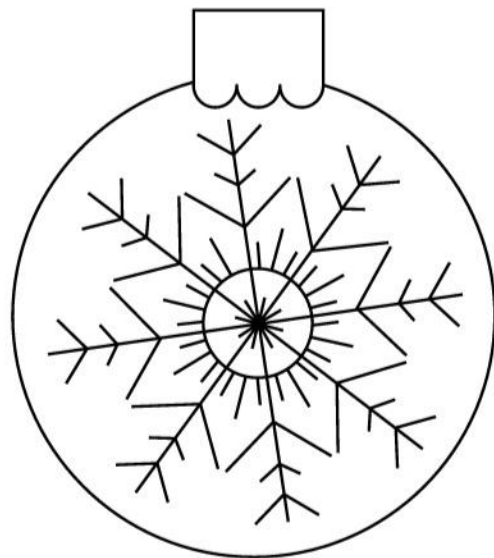
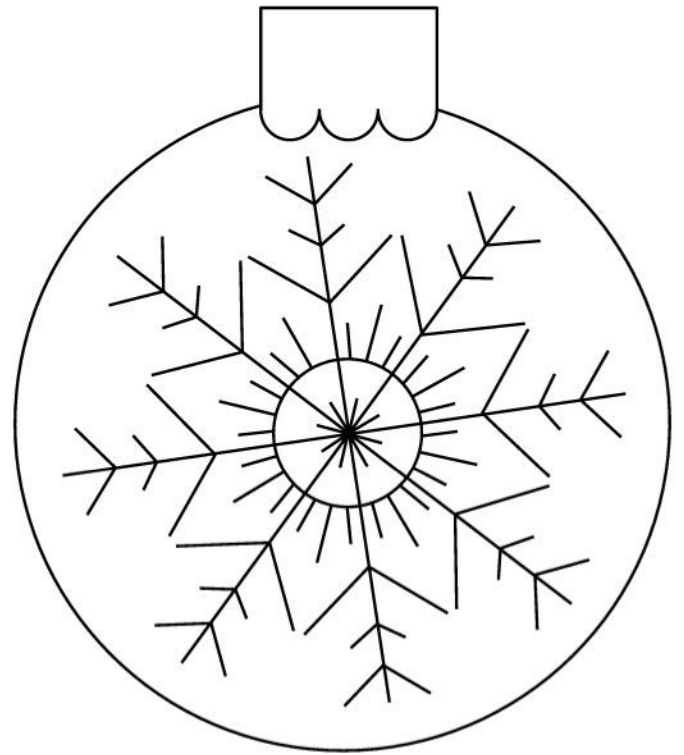
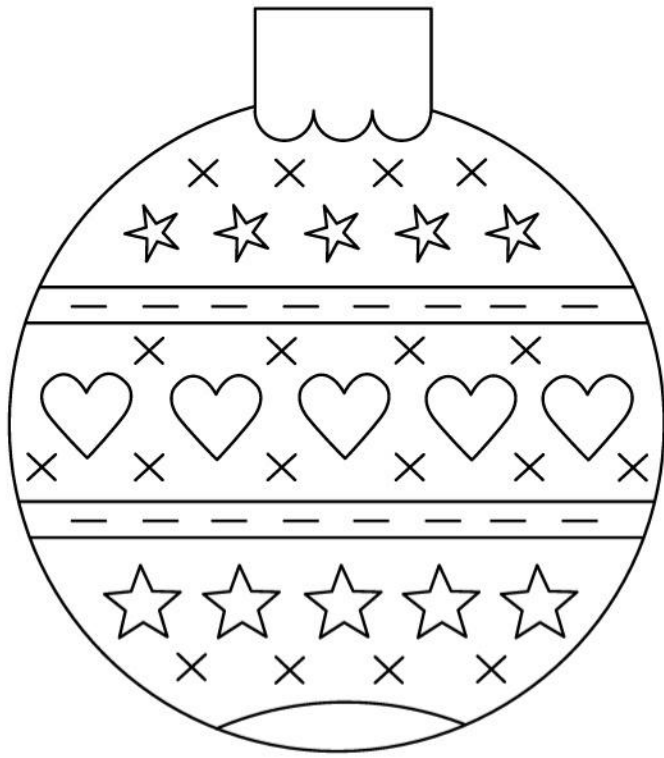

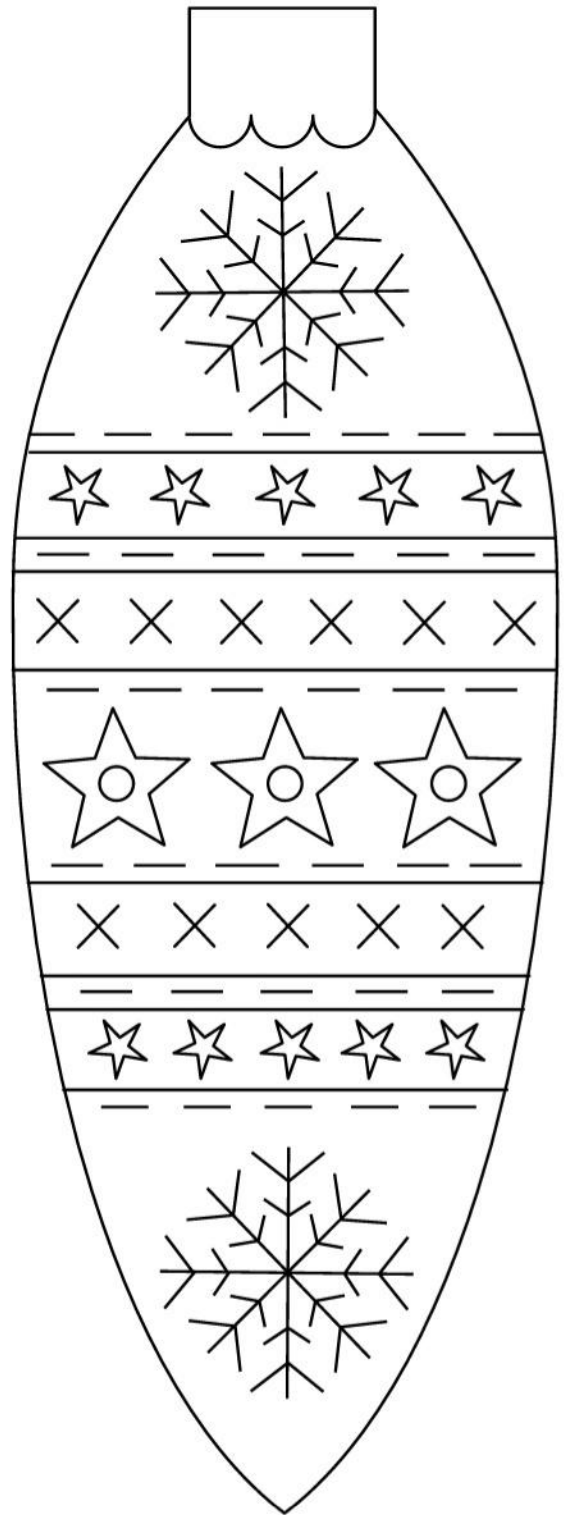
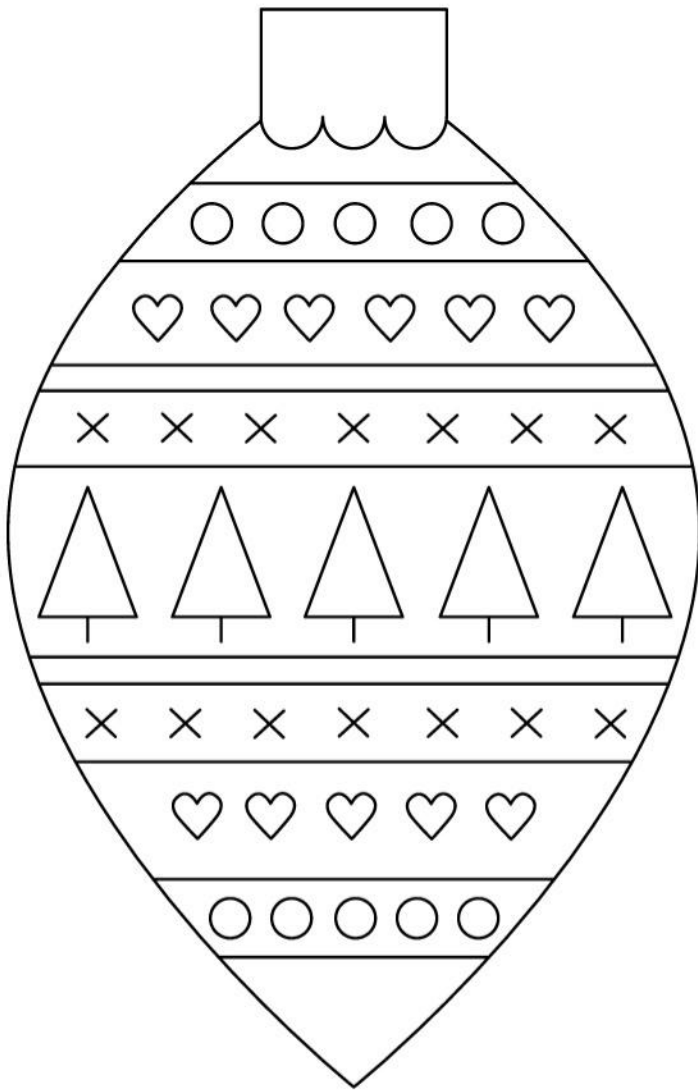

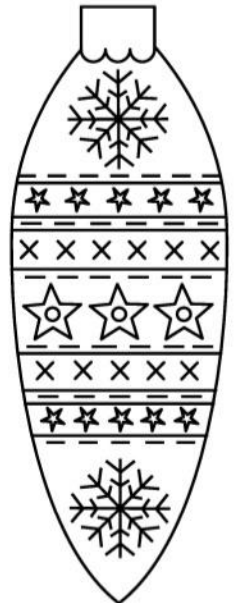
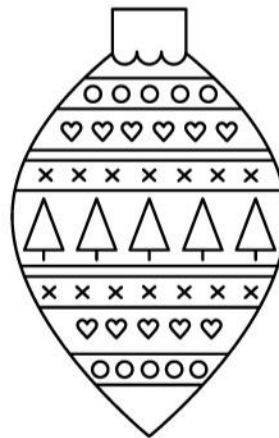
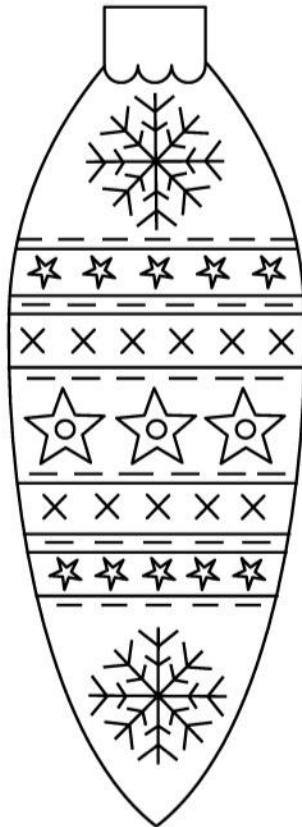
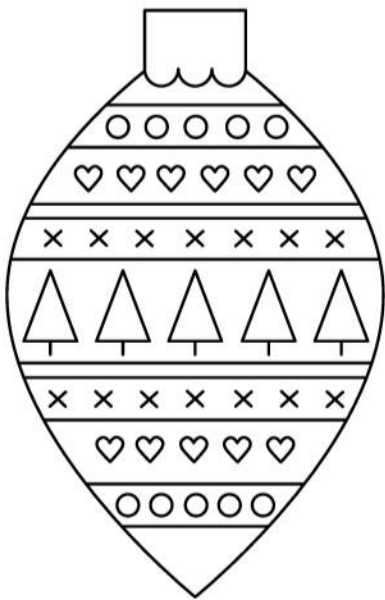
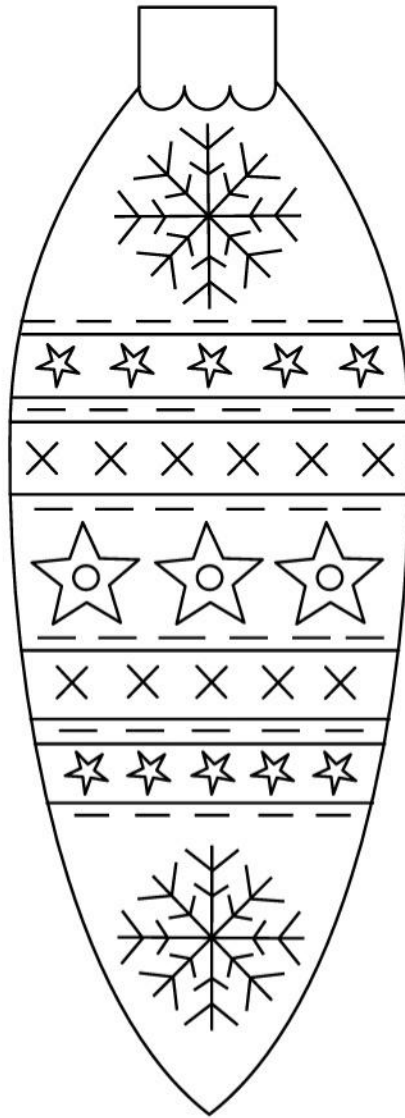
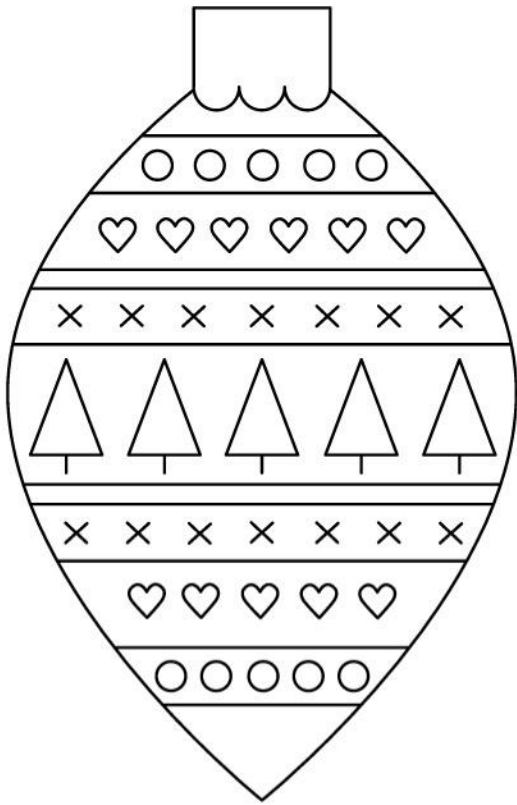

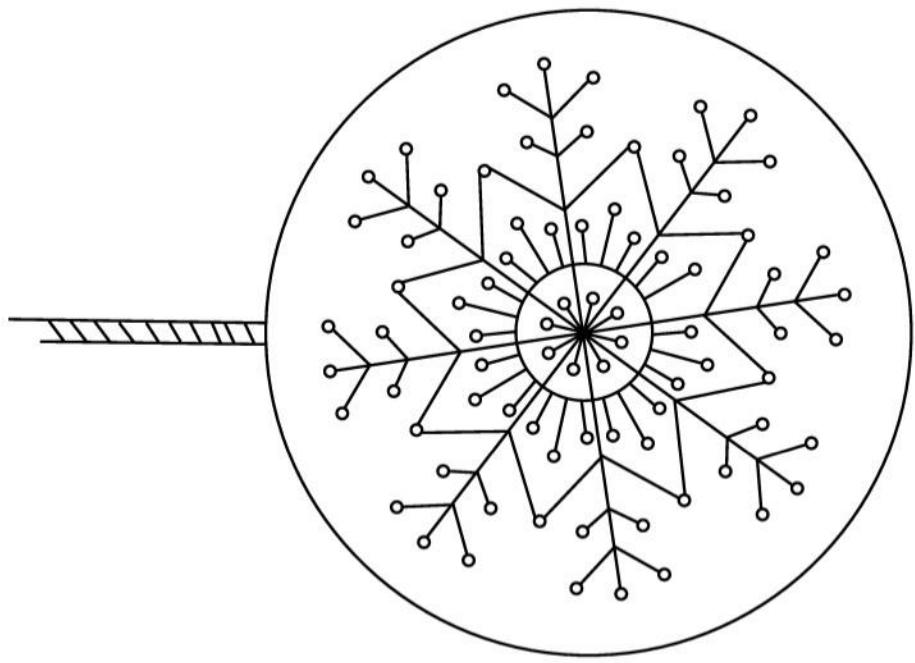
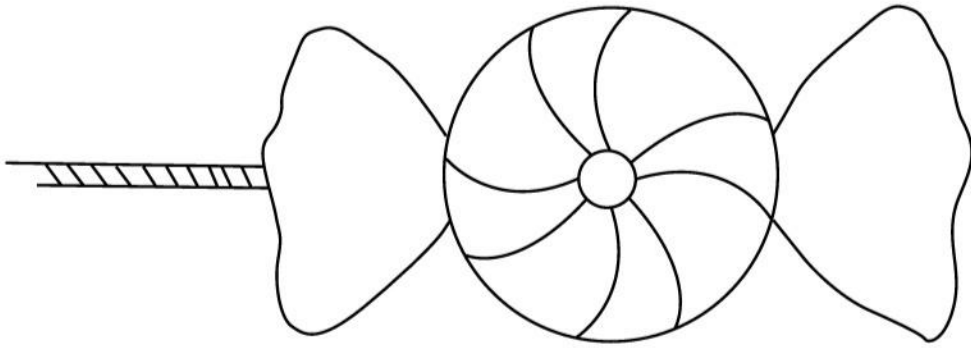
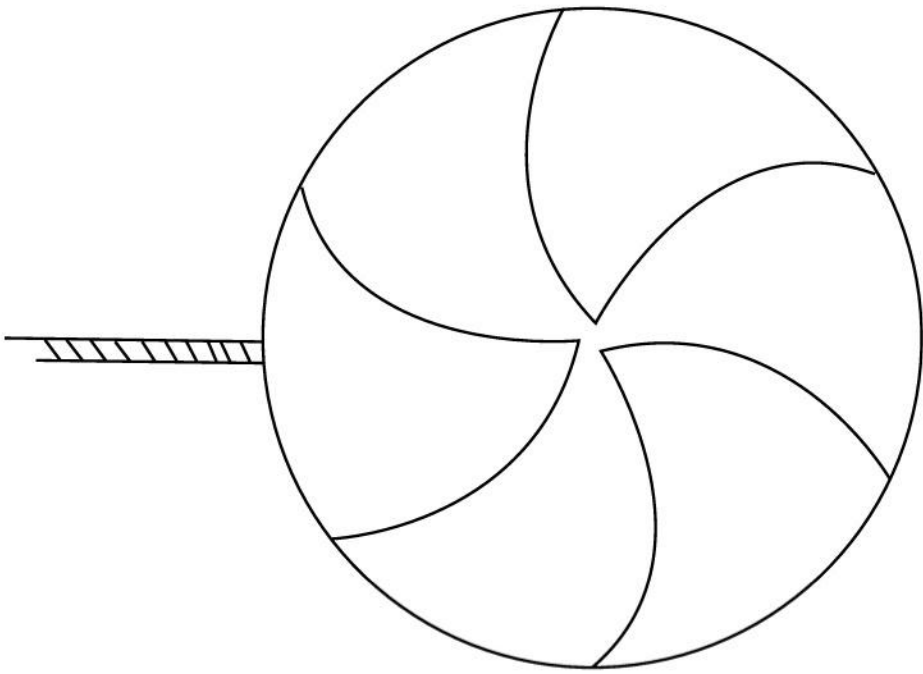

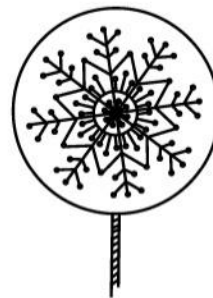
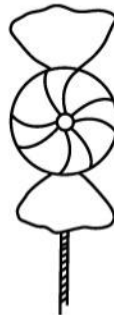
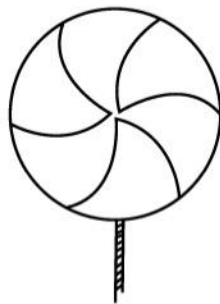
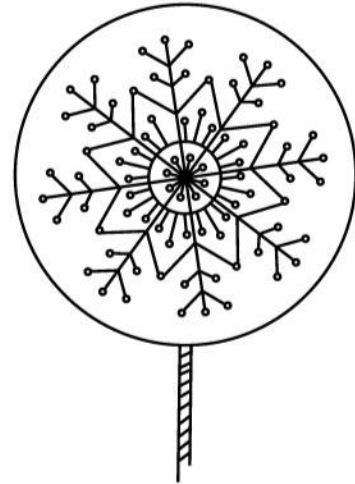
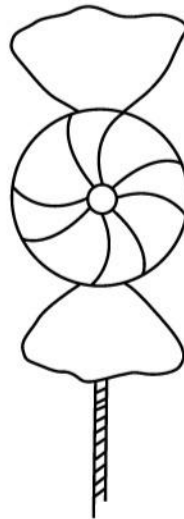
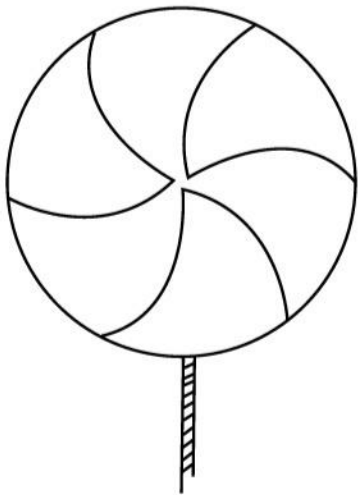
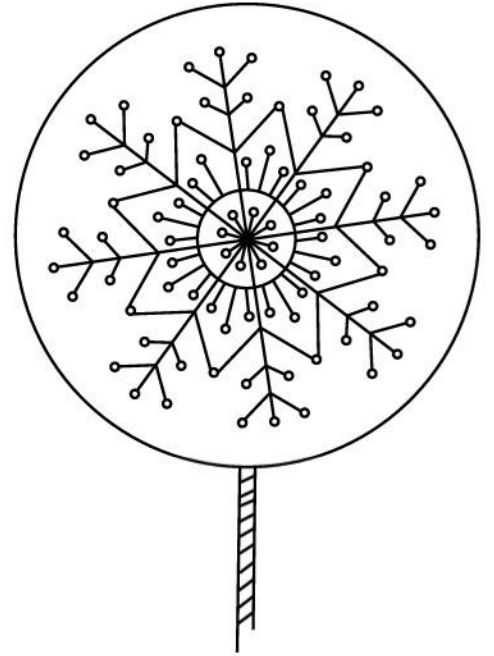
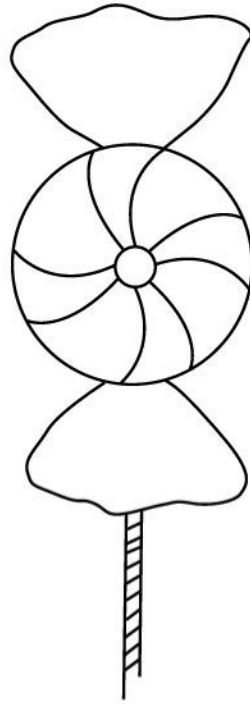
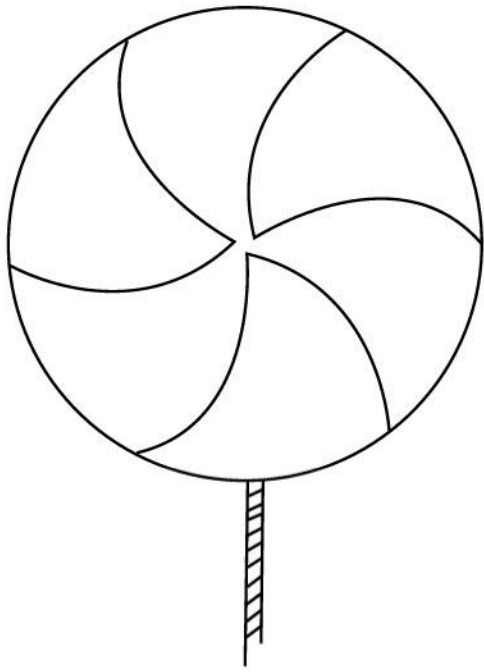

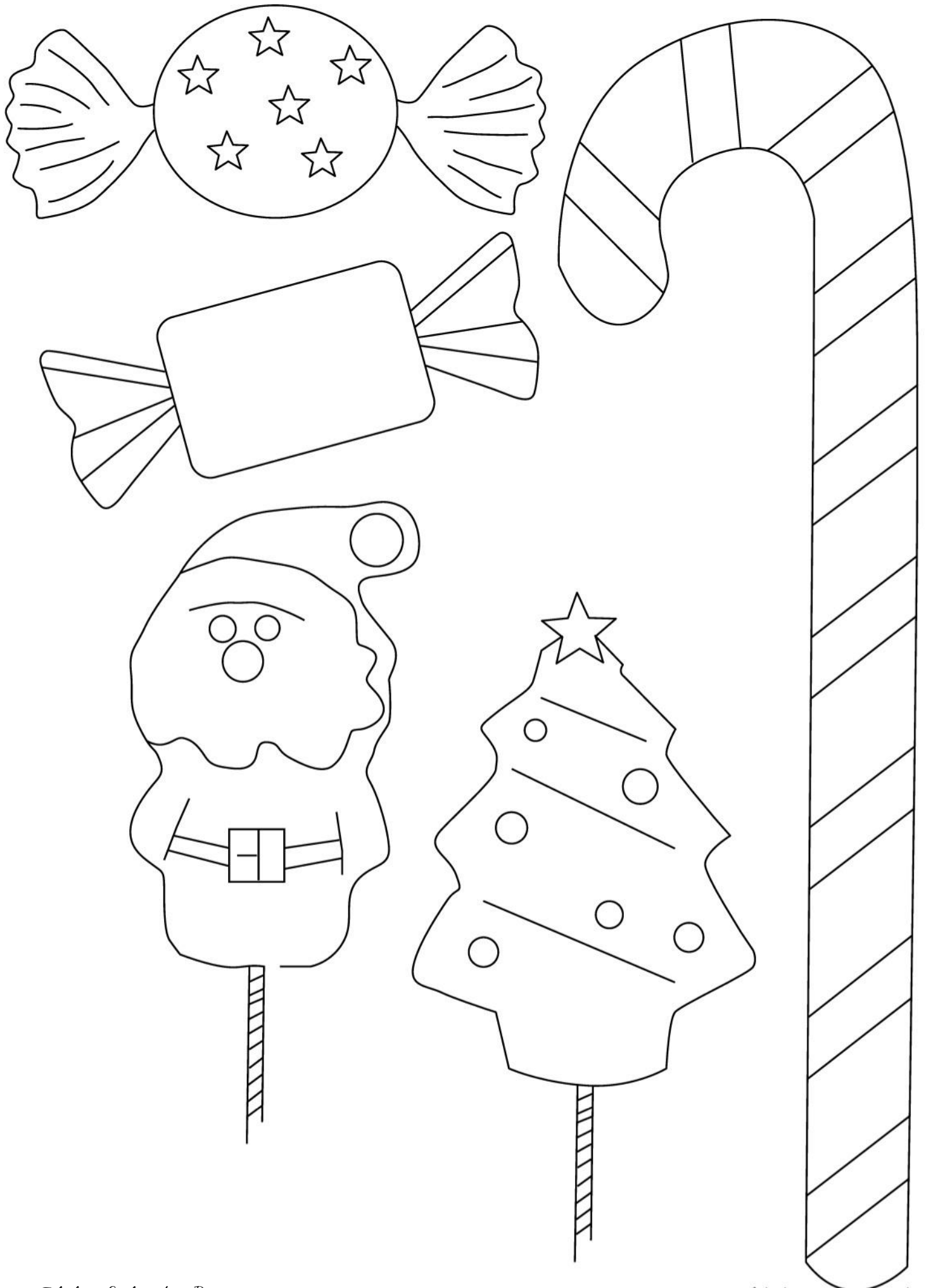

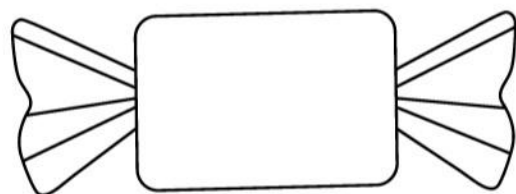
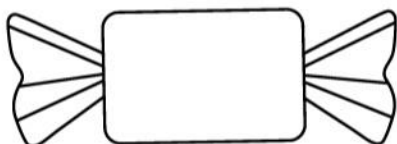
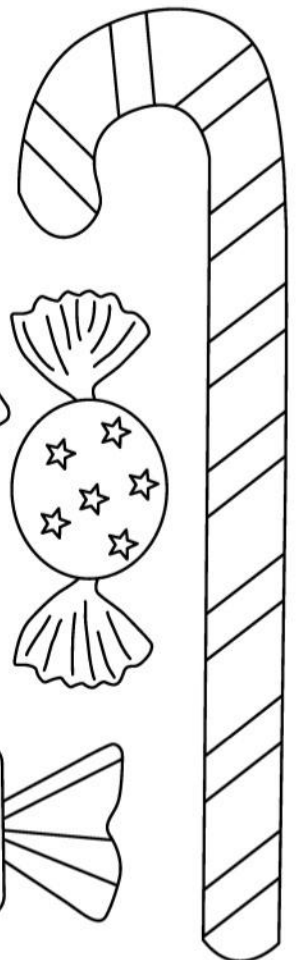
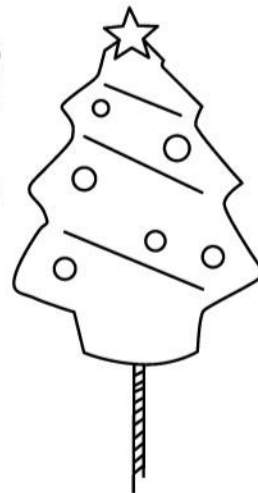
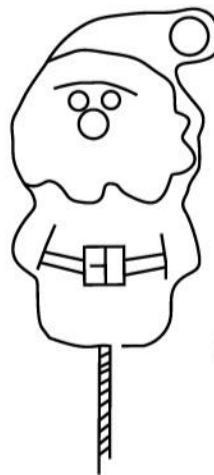
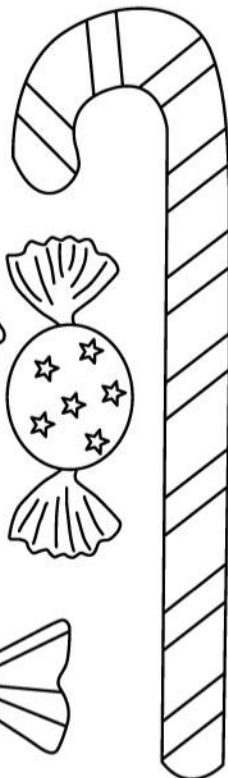
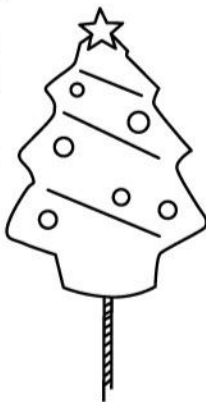
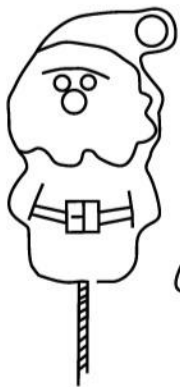
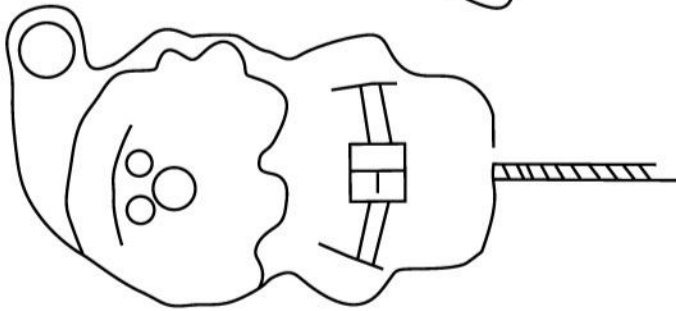
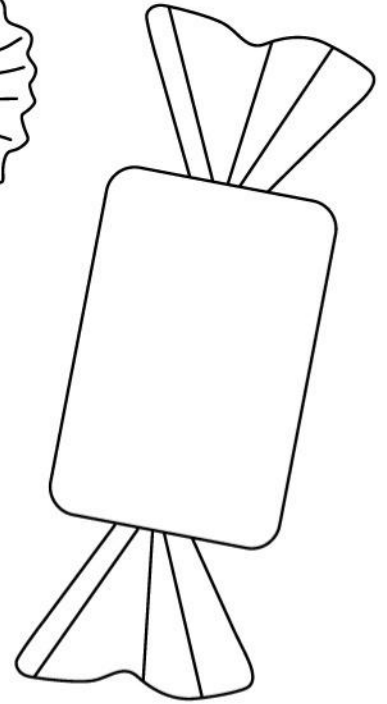
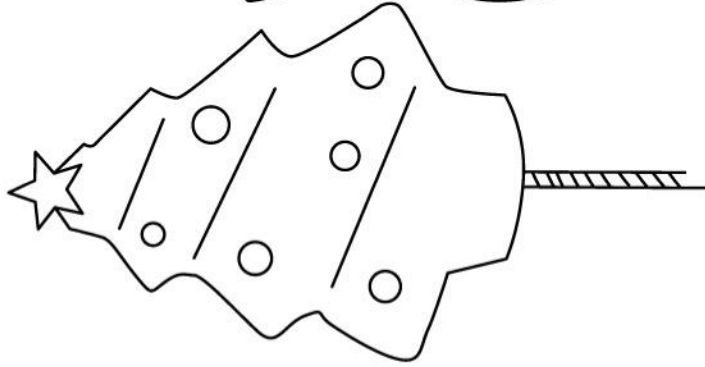
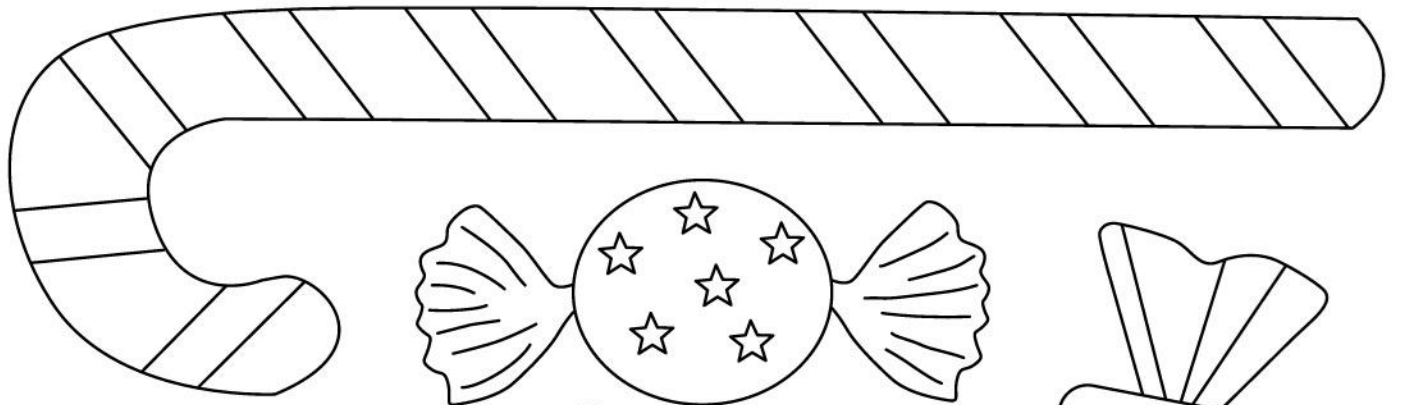

A B C D E F G
H I J K L M N O P
Q R S T U V X Y Z
a b c d e f g h i j k l
m n o p q r s t u v w
x y z

Merry Christmas
Happy Christmas

A B C D E F G

H I J K L M N O P

Q R S T U V X Y Z

a b c d e f g h i j k l

m n o p q r s t u v w

x y z

Merry Christmas

Happy Christmas

A B C D E F G

H I J K L M N O P

Q R S T U V X Y Z

a b c d e f g h i j k l

m n o p q r s t u v w

x y z

Merry Christmas

Happy Christmas





COSY
winter
Christmas
HOLLY
ELF
berries
presents
BERRIES
WREATH
candy
Santa Claus
REINDEER
STOCKING
cookies
sleigh
JUMPER

NEW

ON SALE NOW

WWW.FABULOUSPATTERNS.CO.UK

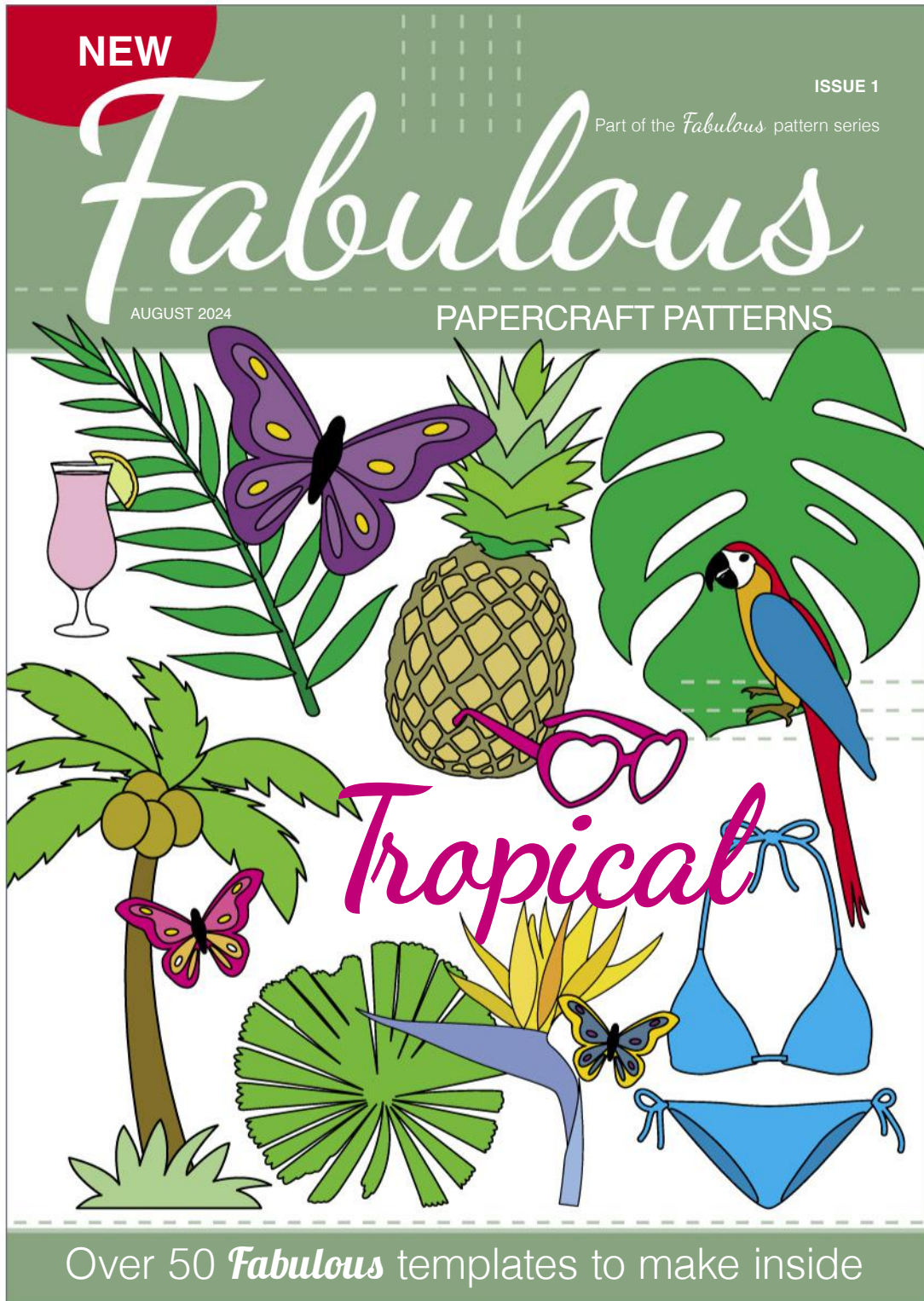

THEMED PATTERNS – ALL SKILL LEVELS – EVERY MONTH

Part of the *Fabulous* pattern series

NEW

ON SALE NOW

WWW.FABULOUSPATTERNS.CO.UK

NEW

Part of the *Fabulous* pattern series
ISSUE 2
Anniversary Special

Fabulous

AUGUST 2024

EMBROIDERY PATTERNS

Alice
IN WONDERLAND

Over **50** *Fabulous* patterns to make inside

THEMED PATTERNS – ALL SKILL LEVELS – EVERY MONTH

Part of the *Fabulous* pattern series